



- SCALPEL HANDLES
- RETRACTORS
- ORTHOPEDICS



# SURGICAL INSTRUMENTS

Email : [info@elgeninstruments.com](mailto:info@elgeninstruments.com)  
Web : [www.elgeninstruments.com](http://www.elgeninstruments.com)

Categories	Page
SCALPEL HANDELS	1-2
SUPER -CUT SCISSORS	1
TUNGSTEN CARBIDE SCISSORS	1-2
OPERATING SCISSORS	2
SUTURE SCISSORS	2
SUTURE AND WIRE CUTTING SCISSORS	3-4
BANDAGE AND UTILITY SCISSORS	4
PROBES AND SUCTION TUBES	4
SUTURE INSTRUMENTS	4
FORCEPS AND RETRACTORS	4
RETRACTORS	5
RETRACTORS AND PROBES	5
PROBES AND NEEDLE HOLDERS	5
NEEDLE HOLDERS	6
TUNGSTEN CARBIDE NEEDLE HOLDERS	6
BANDAGE AND UTILITY SCISSORS	7
ORTHOPEDIC INSTRUMENTS	7-8
DEBAKEY FORCEPS	8
CARDIO AND NEURO SURGERY INSTRUMENTS	9
DERMAL INSTRUMENTS	9
TUNGSTEN SUPER SHARP SCISSORS	9
INTESTINAL FORCEPS	10
STOMACH, INTESTINES, RECTUM	10
UROLOGY	10
UROLOGY & GYNECOLOGY	10
GYNECOLOGY	11
EYE INSTRUMENTS	11
EAR INSTRUMENTS	11
NAIL INSTRUMENTS	12
SURGERY SETS	12
NAIL NIPPERS	12

**DIAGNOSTIC INSTRUMENTS AND SCALPEL HANDL SCALPEL HANDLES**



**WARTENBERG  
NEUROLOGICAL PIN WHEEL**  
17-150-18  
7" (178mm)



**TAYLOR PERCUSSION HAMMER**  
17-190-18      17-190-20  
7" (178mm)      8" (203mm)  
Small              large

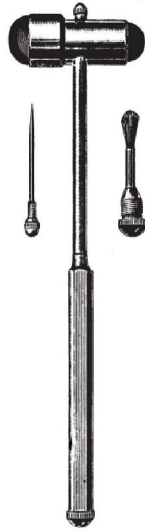

**BUCK NEUROLOGICAL HAMMER**  
17-156-18      7 3/4" (195mm)  
with brush and needle



**MINI SCALPEL HANDLE # 3K**  
01-012-10  
10cm, 4"



**SCALPEL HANDLE #4**  
10-100-04  
for blades 20 through 25



**SCALPEL HANDLE # 3**  
10-130-04  
for blades 10 through 15



**SCALPEL HANDLE # 3**  
10-130-05  
for blades 10 through 15



**SCALPEL HANDLE # 3L**  
10-133-31  
extra long  
8 1/2" (216mm)  
for blades 10 through 15



**SCALPEL HANDLE # 7**  
10-137-07  
for blades 10 through 15



**SCALPEL HANDLE # 9**  
10-137-09  
for blades 10 through 15 extra fine

**SUPER -CUT SCISSORS**

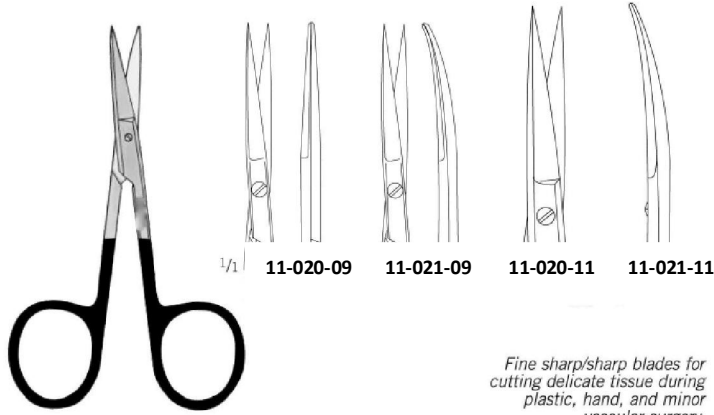

**SUPER-CUT IRIS SCISSORS sharp points**

***Straight***

11-020-09 3 1/2" (89mm) delicate

11-020-11 4 1/2" (114mm)

***curved***

11-021-09 3 1/2" (89mm) delicate



**SUPER-CUT STEVENS SCISSORS**

**blunt points**

***straight***

11-028-11 4 1/2" 11-029-11 4 1/2" (114mm)

***curved***

11-029-14 5 1/4" (133mm)

## SUPER-CUT SCISSORS

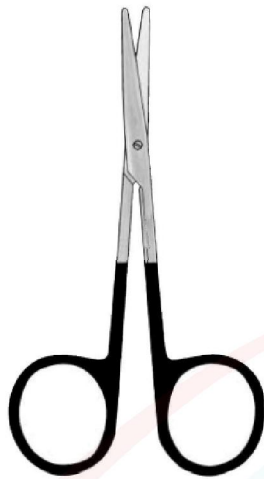

**SUPER-CUT BABY  
METZENBAUM SCISSORS**  
KM 35-364  
4 1/2" (114mm)  
straight

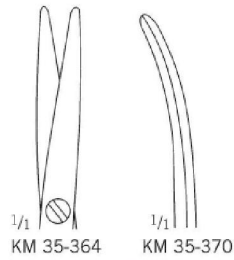

Flat, blunt scissors for  
dissecting soft tissue.

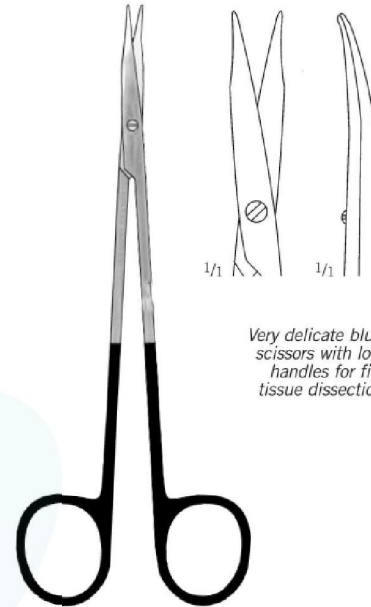

**SUPER-CUT JAMISON SCISSORS**  
KM 35-496  
6 1/4" (159mm)  
curved blunt points, very delicate

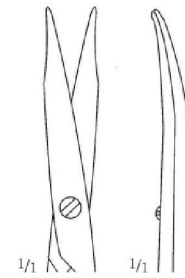

Very delicate blunt  
scissors with long  
handles for fine  
tissue dissection.

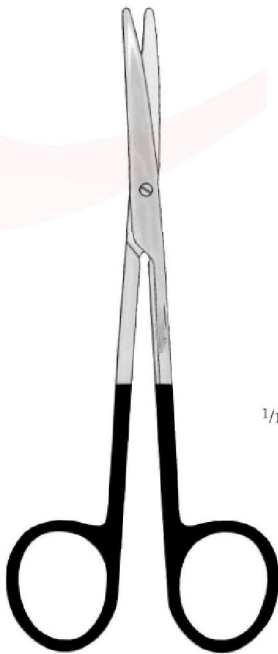

**SUPER-CUT METZENBAUM SCISSORS** blunt points

<i>straight</i>	<i>curved</i>		
KM 35-380 6" (152mm)	KM 35-382 6" (152mm)		
KM 35-392 7" (178mm)	KM 35-394 7" (178mm)		
	KM 35-396 7" (178mm) delicate		
	KM 35-406 8" (203mm)		
	KM 35-418 9" (229mm)		
	KM 35-430 11" (279mm)		

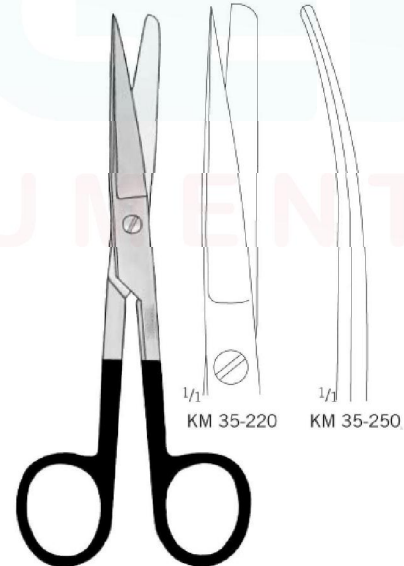
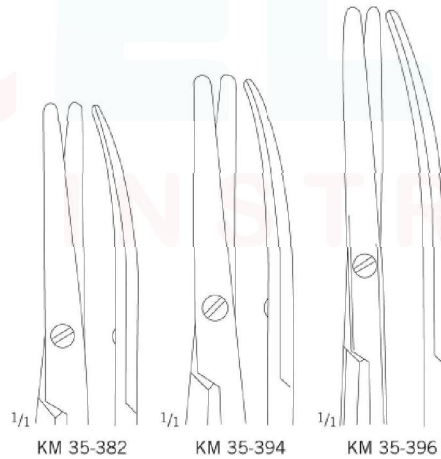

**SUPER-CUT OPERATING SCISSORS**

KM 35-220	KM 35-250
5 1/2" (140mm)	5 1/2" (140mm)
straight	curved
sharp/blunt	sharp/blunt

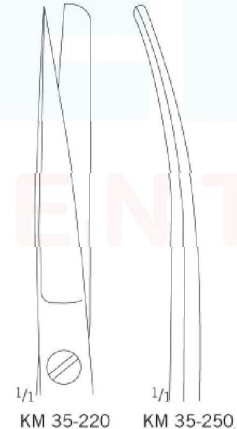

## SUPER-CUT SCISSORS

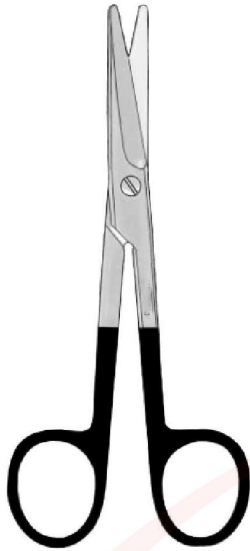

KM 35-280

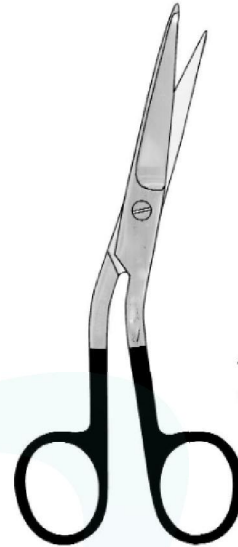

The delicate offset shanks provide increased leverage. The fine knob slides easily under finger and toe bandages. Excellent for small bandages!

### SUPER-CUT MAYO SCISSORS

beveled blades, blunt points

straight

KM 35-280 5 1/2" (140mm)

KM 35-292 6 3/4" (171mm)

KM 35-316 9" (229mm)

curved

KM 35-286 5 1/2" (140mm)

KM 35-298 6 3/4" (171mm)

KM 35-322 9" (229mm)

KM 35-340 11" (279mm)

### SUPER-CUT HI-LEVEL BANDAGE SCISSORS

KM 35-202

5 1/2" (140mm)

shanks angled on side

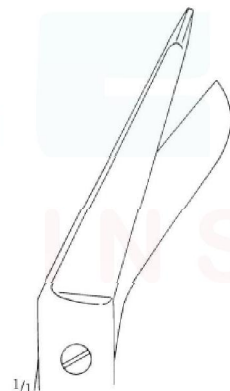
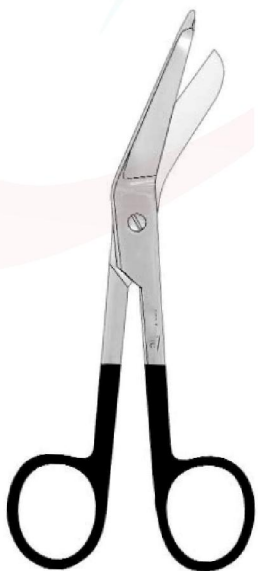

KM 35-210

Cuts bandages and multiple layers of dressings with ease. Razor sharp blades reduce hand fatigue.

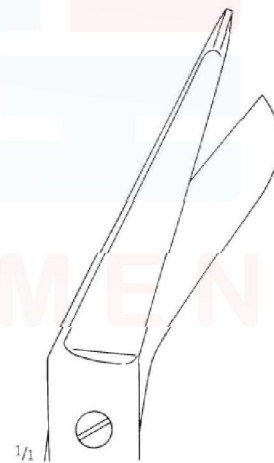
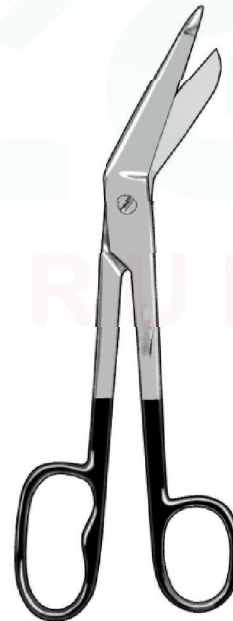

All the benefits of our Super-Cut Lister scissors plus an oversized finger ring, which helps relieve pressure on the third metacarpal.

### SUPER-CUT LISTER BANDAGE SCISSORS

KM 35-210

KM 35-212

5 1/2" (140mm)

7 1/4" (184mm)

### SUPER-CUT LISTER BANDAGE SCISSORS WITH LARGE FINGER RING

KM 35-214

8" (203mm)

## TUNGSTEN CARBIDE SCISSORS

Tungsten carbide (TC) is one of the hardest alloys made today. Our TC scissors have tungsten carbide firmly bonded to both cutting edges. We guarantee that they will stay sharp for at least three years. The finger rings are gold plated for easy identification.



**TC IRIS SCISSORS**  
 11-982-11 11-983-11  
 4 ½" (114mm)  
 straight  
 sharp points

4 ½" (114mm)  
 curved  
 sharp points

**BLEPHAROPLASTY SCISSORS**  
 11-990-11  
 4 ½" (114mm) curved flatti ps, one  
 serrated and one carbide blade

**TC STRABISMUS SCISSORS**  
 11-932-11 11-933-11  
 4 ½" (114mm) 4 ½" (114mm)  
 straight curved  
 blunt points blunt points



**TC OPERATING SCISSORS**  
 11-902-14 11-903-14  
 5 ½" (140mm) 5 ½" (140mm)  
 Straight curved  
 sharp/blunt sharp/blunt

**TC METZENBAUM SCISSORS** blunt points  
 straight curved  
 11-942-15 6" 11-943-15 6" (152mm)  
 11-942-18 7" 11-943-18 7" (178mm)  
 11-942-23 9" 11-943-23 9" (229mm)

**TC MAYO SCISSORS** beveled blades  
 straight curved  
 11-910-14 5 ½" 11-911-14 5 ½" (140mm)  
 11-910-16 6 ¼" 11-911-16 6 ¼" (171mm)  
 11-910-23 9" 11-911-23 9" (229mm)

## OPERATING SCISSORS

Most scissors can be serrated upon request.

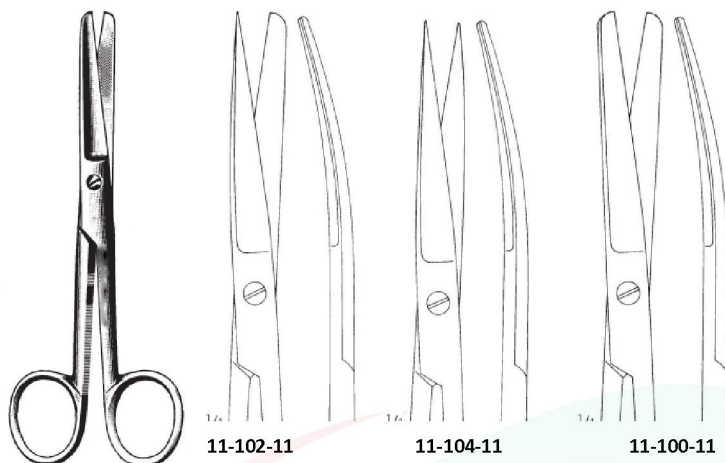

**OPERATING SCISSORS straight**  
 11-100-11 4 1/2" (114mm) blunt/blunt  
 11-102-11 4 1/2" (114mm) sharp/blunt  
 11-104-11 4 1/2" (114mm) sharp/sharp  
 11-100-13 5 (127mm) blunt/blunt  
 11-102-13 5 (127mm) sharp/blunt  
 11-104-13 5 (127mm) sharp/sharp  
 11-100-14 5 1/2" (140mm) blunt/blunt  
 11-102-14 5 1/2" (140mm) sharp/blunt  
 11-102-14 5 1/2" (140mm) sharp/sharp  
 11-100-16 6 1/2" (165mm) blunt/blunt  
 11-102-16 6 1/2" (165mm) sharp/blunt  
 11-104-16 6 1/2" (165mm) sharp/sharp

**OPERATING SCISSORS curved**  
 11-101-11 4 1/2" (114mm) blunt/blunt  
 11-103-11 4 1/2" (114mm) sharp/blunt  
 11-105-11 4 1/2" (114mm) sharp/sharp  
 11-101-13 5 (127mm) blunt/blunt  
 11-103-13 5 (127mm) sharp/blunt  
 11-105-13 5 (127mm) sharp/sharp  
 11-101-14 5 1/2" (140mm) blunt/blunt  
 11-103-14 5 1/2" (140mm) sharp/blunt  
 11-105-14 5 1/2" (140mm) sharp/sharp  
 11-101-16 6 1/2" (165mm) blunt/blunt  
 11-103-16 6 1/2" (165mm) sharp/blunt  
 11-105-16 6 1/2" (165mm) sharp/sharp

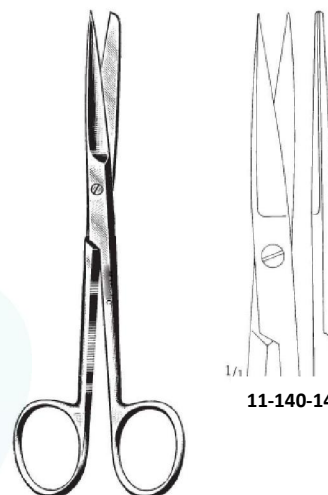

**DEAVER SCISSORS 5 1/2" (140mm)**  
*straight* *curved*  
 11-140-14 sharp/blunt 11-141-14 sharp/blunt  
 11-144-14 sharp/sharp 11-145-14 sharp/sharp

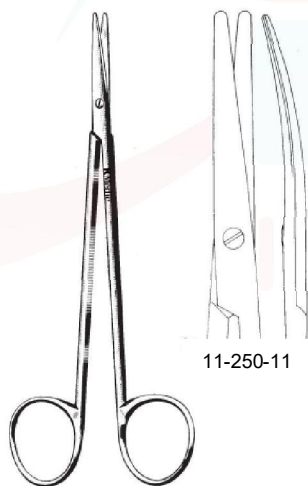

**METZENBAUM SCISSORS blunt points**  
*Straight* *curved*  
 11-250-11 4 1/2" 11-251-11 4 1/2" (114mm)  
 11-264-15 6" 11-327-14 5 3/4" (146mm) del.  
 11-250-18 7" 11-265-15 6" (152mm)  
 11-250-20 8" 11-251-18 7" (178mm)  
 11-250-23 9" 11-331-18 7" (178mm) del.  
 11-250-28 11" 11-251-20 8" (203mm)  
 11-251-23 9" (229mm)  
 11-251-28 11" (279mm)

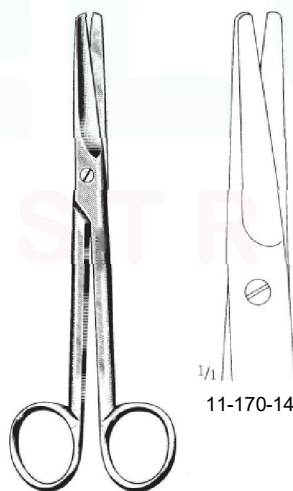

**MAYO SCISSORS beveled blades**  
*straight* *curved*  
 11-170-14 5 1/2" 11-171-14 5 1/2" (140mm)  
 11-170-17 6 1/4" 11-171-17 6 1/4" (171mm)  
 11-170-17 9" 11-171-17 9" (229mm)  
 serrated serrated  
 11-176-17 6 1/4" 11-177-17 6 1/4" (171mm)

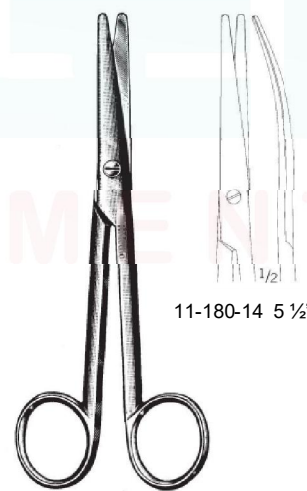

**MAYO-STILLE SCISSORS rounded blades**  
*Straight* *curved*  
 11-180-14 5 1/2" 11-181-14 5 1/2" (140mm)  
 11-181-17 6 3/4" 11-181-17 6 3/4" (171mm)



## OPERATING SCISSORS

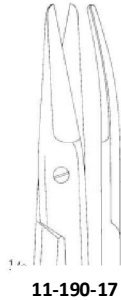
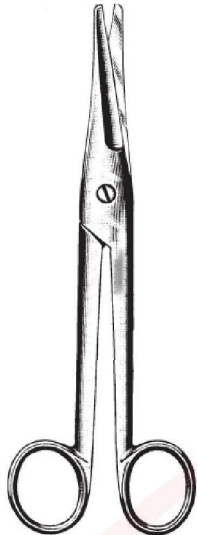

**MAYO-NOBLE SCISSORS** beveled blades  
 11-190-17 11-190-17  
 6 1/2" (165mm) 6 1/2" (165mm)  
 straight curved

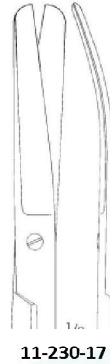
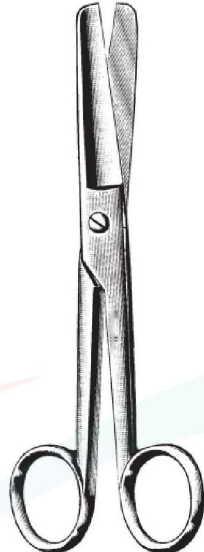

**DOYEN ABDOMINAL SCISSORS**  
 11-230-17 11-231-17  
 7" (178mm) 7" (178mm)  
 straight curved

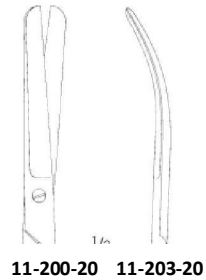
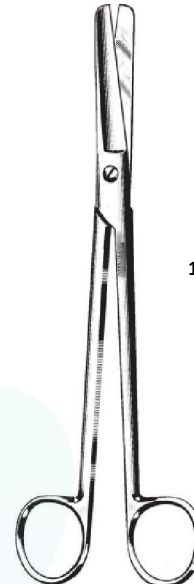

**SIMS SCISSORS** 8" (203mm)  
 straight curved  
 11-200-20 sharp/sharp 11-203-20 sharp/sharp  
 11-201-20 sharp/blunt 11-204-20 sharp/blunt  
 11-202-20 blunt/blunt 11-205-20 blunt/blunt

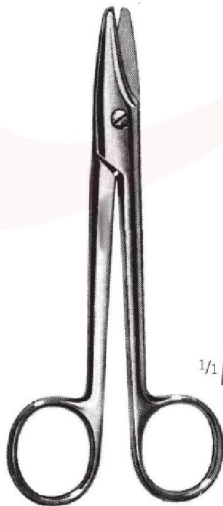

**SISTRUNK SCISSORS** heavy pattern  
 00-100-94 00-101-94  
 5 1/2" (140mm) 5 1/2" (140mm)  
 straight curved

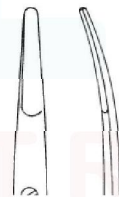

**RAGNELL SCISSORS**  
 11-991-12 11-991-17  
 5" (127mm) 7" (178mm)  
 curved curved  
 flat bluntti ps flat bluntti ps

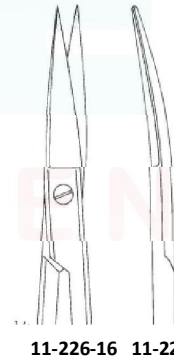

**KELLY FISTULA SCISSORS** 6 1/4" (159mm)  
 smooth sharp/sharp  
 11-226-16 straight  
 11-227-16 curved  
 11-228-16 angular

## OPERATING SCISSORS



### IRIS SCISSORS sharp points

straight	curved
11-630-09 3 1/2"	11-631-09 3 1/2" (89mm)
11-630-11 4 1/2"	11-631-11 4 1/2" (114mm)
11-632-10 4 1/4"	11-633-10 4 1/4" (105mm)
delicate	delicate
	angled on side
	11-635-11 4 1/2" (114mm)

### PLASTIC SURGERY SCISSORS 4 3/4" (121mm)

straight	curved
11-640-11 sharp/sharp	11-641-11 sharp/sharp
11-642-11 sharp/blunt	11-643-11 sharp/blunt
11-644-11 blunt/blunt	11-645-11 blunt/blunt
	angled on side
	11-646-11 sharp/sharp

### STRABISMUS SCISSORS

11-690-11	11-691-11
4" (102mm)	4" (102mm)
straight	curved
blunt points	blunt points

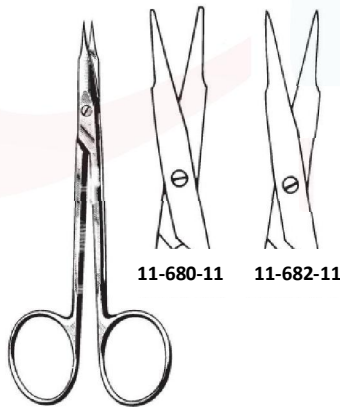

### STEVENS TENOTOMY SCISSORS

straight
11-682-11 4 1/2" (108mm) blunt/blunt
11-680-11 4 1/2" (108mm) sharp/sharp
curved
11-683-11 4 1/2" (108mm) blunt/blunt
11-681-11 4 1/2" (108mm) sharp/sharp

### GRADLE SCISSORS

11-810-10
3 3/4" (95mm) slightly curved
sharp/sharp

### GRADLE SCISSORS

11-812-10
4" (102mm) slightly curved
ribbon type, sharp/sharp

**SUTURE SCISSORS**



**SHORTBENT STITCH SCISSORS**  
 11-817-09  
 3 ½" (89mm)  
 curved on side  
 delicate

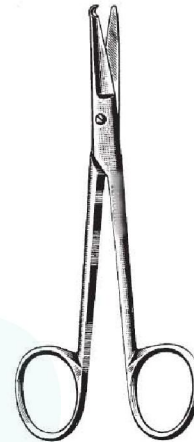

**SPENCER STITCH SCISSORS**  
 11-824-09      11-826-13  
 3 ½" (89mm)      4 ¾" (121mm)  
 delicate      delicate  
 straight      straight

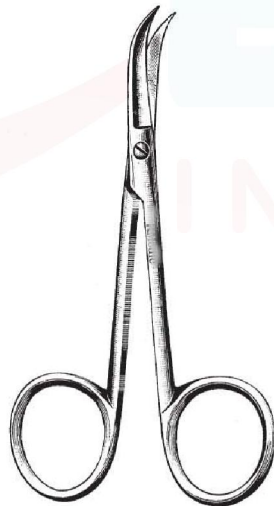

**HILL STITCH SCISSORS**  
 11-828-11  
 4 ½" (108mm)

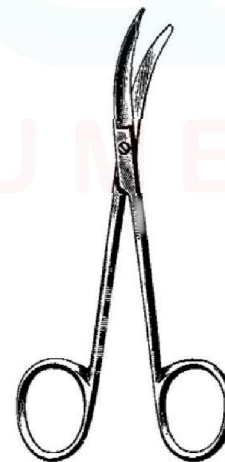

**NORTHBENT STITCH SCISSORS**  
 11-819-13  
 4 ¾" (121mm)  
 curved on side

## SUTURE AND WIRE CUTTING SCISSORS

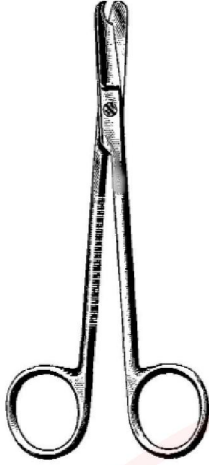

**LITTAUER STITCH SCISSORS**  
 11-834-14  
 5 ½" (140mm)

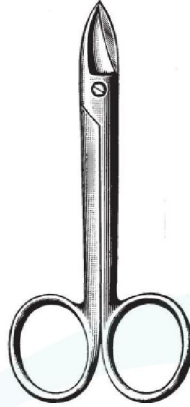

**WIRE CUTTING SCISSORS 4" (102mm)**  
 straight curved  
 11-874-10 smooth 11-875-10 smooth  
 KM 35-170 KM 35-194  
 one serrated blade one serrated blade



11-874-10



**WIRE CUTTING SCISSORS 4 ½" (121mm)**  
 11-865-12  
 one serrated one serrated  
 blade, angular blade, angular  
 carbide

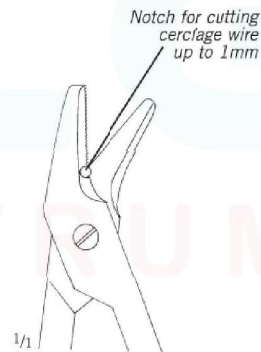

11-865-12

## BANDAGE AND UTILITY SCISSORS

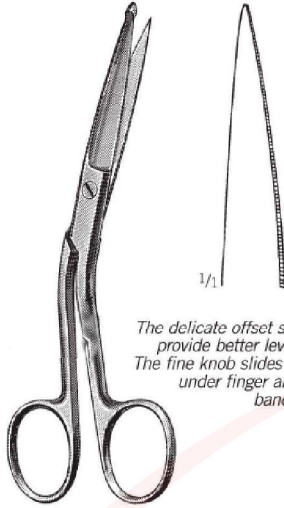

*The delicate offset shanks provide better leverage. The fine knob slides easily under finger and toe bandages.*

**HI-LEVEL BANDAGE SCISSORS**  
21-110-14  
5 ½" (140mm) shanks angled on side  
one serrated blade

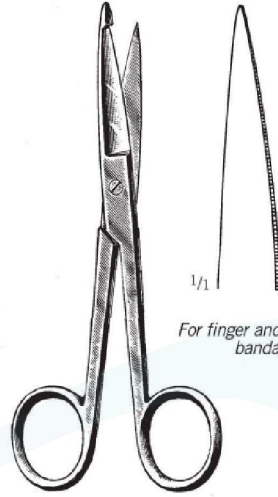

*For finger and toe bandages.*

**KNOWLES BANDAGE SCISSORS**  
21-114-14  
5 ½" (140mm) straight  
one serrated blade

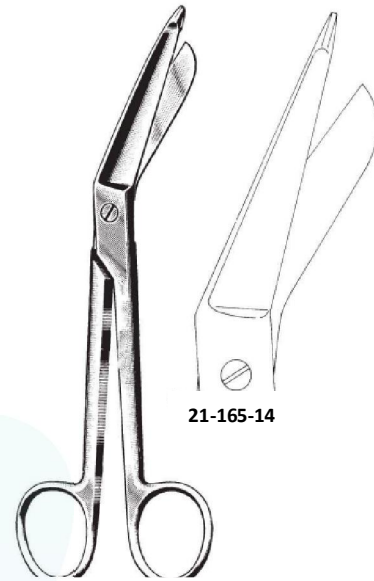

21-165-14

**LISTER BANDAGE SCISSORS**  
21-165-09 3 ½" (89mm)  
21-165-11 4 ½" (114mm)  
21-165-14 5 ½" (140mm)  
21-165-18 7 ¼" (184mm)  
21-167-20 8" (203mm) one large finger ring



**UTILITY SCISSORS** one serrated blade  
21-209-18  
7 ½" (191mm)  
With autoclavable plastic finger rings.

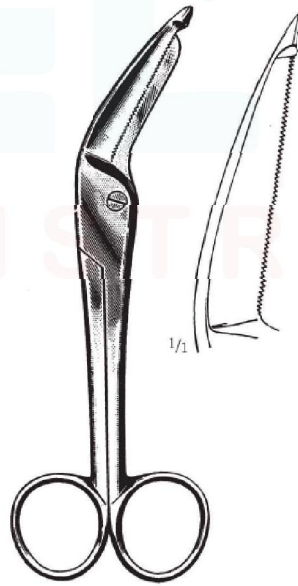

**HERCULES SCISSORS**  
21-120-18  
7 ½" (191mm) heavy duty  
one serrated blade



**KMEDIC UTILITY SHEARS**  
21-124-20  
8" (203mm) with wire cutting notch  
one serrated blade

## PROBES AND SUCTION TUBES



### PROBE WITH EYE malleable stainless

- 16-108-11 4½" (114mm)
- 16-108-12 5" (127mm)
- 16-108-14 5½" (140mm)
- 16-108-16 6" (152mm)
- 16-108-20 8" (203mm)
- 16-108-25 10" (254mm)
- 16-108-30 12" (305mm)



### GROOVED DIRECTORS

- with tongue tie
- 16-160-11 4½" (114mm)
- 16-160-12 5" (127mm)
- 16-160-14 5½" (140mm)
- with probe and tongue tie
- 16-170-12 5" (127mm)
- 16-170-14 5½" (140mm)
- 16-170-15 6" (152mm)



1 french = .33mm

### BARON SUCTION TUBE 5 ½" (140mm)

- 01-100-95 3 french
- 01-100-95 5 french
- 01-100-95 7 french



1 french = .33mm

### FRAZIER SUCTION TUBE 7" (178mm)

- 18-523-06 6 french
- 18-523-07 7 french
- 18-523-08 8 french
- 18-523-10 10 french
- 18-523-12 12 french



### YANKAUER SUCTION TUBE

- 18-545-11 18-545-13
- 11 ½" (292mm) chrome front p only



1 french = .33mm

### POOLE SUCTION TUBE 9" (229mm)

- chrome
- 18-550-22 23 french curved
- 18-551-22 30 french straight

## SUTURE INSTRUMENTS



WACHENFELDT CLIP APPLYING  
AND REMOVING FORCEPS  
20-924-12  
5" (127mm)



MICHEL CLIP APPLYING FORCEPS  
20-916-12  
5" (127mm)



WACHENFELDT CLIP APPLYING  
AND REMOVING FORCEPS  
20-924-12  
5" (127mm) cross action



MICHEL CLIP APPLYING  
AND REMOVING FORCEPS  
20-928-12  
5" (127mm) double ended



CASTROVIEJO MICRO TYING FORCEPS  
4( 102mm)  
straight, with tying platform  
35-618-05 35-618-10  
0.12mm 0.5mm  
1x2 teeth 1x2 teeth



DESCHAMPS LIGATURE CARRIER  
8( 203mm)  
20-841-20 blunt left  
20-842-20 blunt right  
20-843-20 sharp left  
20-844-20 sharp right

## HEMOSTATIC FORCEPS



**HARTMANN MOSQUITO FORCEPS**  
 13-306-10 13-307-10  
 3 ½" (89mm) 3 ½" (89mm)  
 straight curved



**HALSTED MOSQUITO FORCEPS 5" (127mm)**  
 straight curved  
 13-310-12 13-311-12  
 13-314-05 delicate 13-314-05 delicate  
 13-312-12 1x2 teeth 13-313-12 1x2 teeth

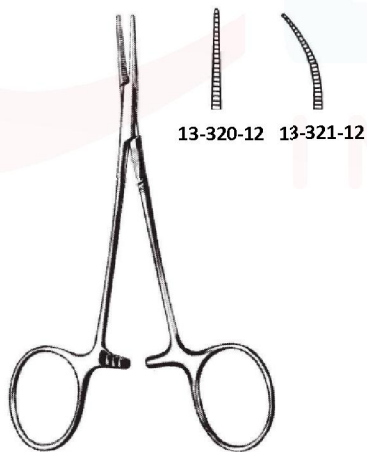
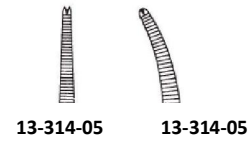
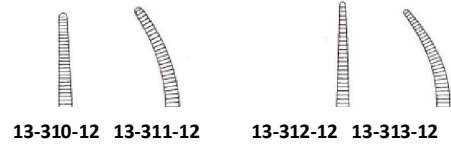

**HARTMANN MOSQUITO FORCEPS**  
 13-320-12 13-321-12  
 3 ½" (89mm) 3 ½" (89mm)  
 straight curved

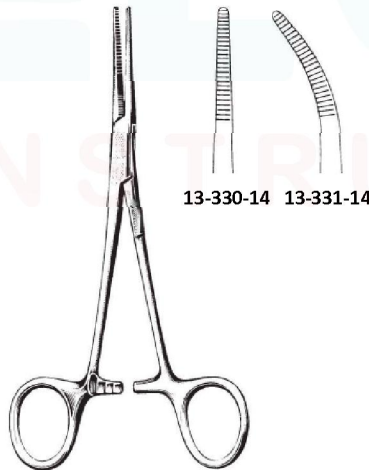

**KELLY FORCEPS**  
 13-330-14 13-331-14  
 5 ½" (140mm) 5 ½" (140mm)  
 straight curved



**RANKIN-KELLY FORCEPS**  
 13-334-16 13-335-16  
 6 ¼" (159mm) 6 ¼" (159mm)  
 straight curved



## HEMOSTATIC FORCEPS

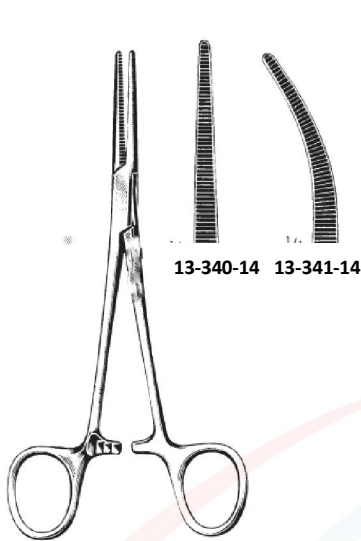

13-340-14 13-341-14

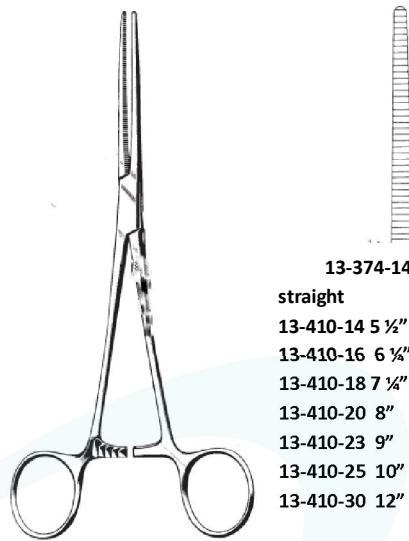

13-374-14

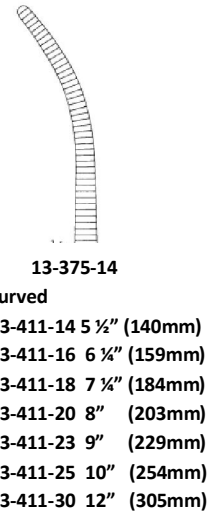

13-375-14

straight

- 13-410-14 5 1/2"
- 13-410-16 6 1/4"
- 13-410-18 7 1/4"
- 13-410-20 8"
- 13-410-23 9"
- 13-410-25 10"
- 13-410-30 12"

curved

- 13-411-14 5 1/2" (140mm)
- 13-411-16 6 1/4" (159mm)
- 13-411-18 7 1/4" (184mm)
- 13-411-20 8" (203mm)
- 13-411-23 9" (229mm)
- 13-411-25 10" (254mm)
- 13-411-30 12" (305mm)

### CRILE FORCEPS

straight

- 13-340-14 5 1/2"
- 13-342-14 5 1/2" (1 x 2)

curved

- 13-341-14 5 1/2" (140mm)
- 13-343-14 5 1/2" (140mm) (1 x 2)

Crile-Rankin

- 13-346-16 6 1/4"

- 13-347-14 6 1/4" (159mm)

### ROCHESTER PEAN FORCEPS



13-324-14 13-325-14  
FORCEPS

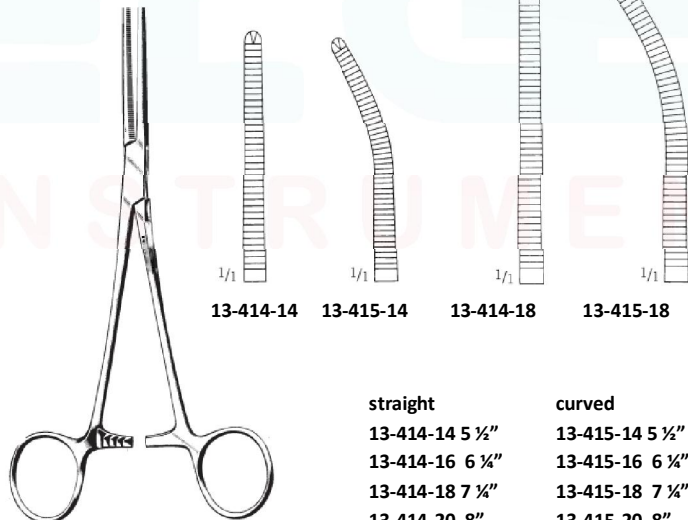

13-414-14 13-415-14 13-414-18 13-415-18

straight

- 13-414-14 5 1/2"
- 13-414-16 6 1/4"
- 13-414-18 7 1/4"
- 13-414-20 8"
- 13-414-23 9"
- 13-414-25 10"
- 13-414-30 12"

curved

- 13-415-14 5 1/2" (140mm)
- 13-415-16 6 1/4" (159mm)
- 13-415-18 7 1/4" (184mm)
- 13-415-20 8" (203mm)
- 13-415-23 9" (229mm)
- 13-415-25 10" (254mm)
- 13-415-30 12" (305mm)

### PROVIDENCE HOSPITAL FORCEPS

- 13-324-14 13-325-14
- 5 1/2" (140mm) straight
- 5 1/2" (140mm) curved

### ROCHESTER-OCHSNER FORCEPS 1x2 teeth

- 13-414-14 13-415-14 13-414-18 13-415-18

### HEMOSTATIC FORCEPS

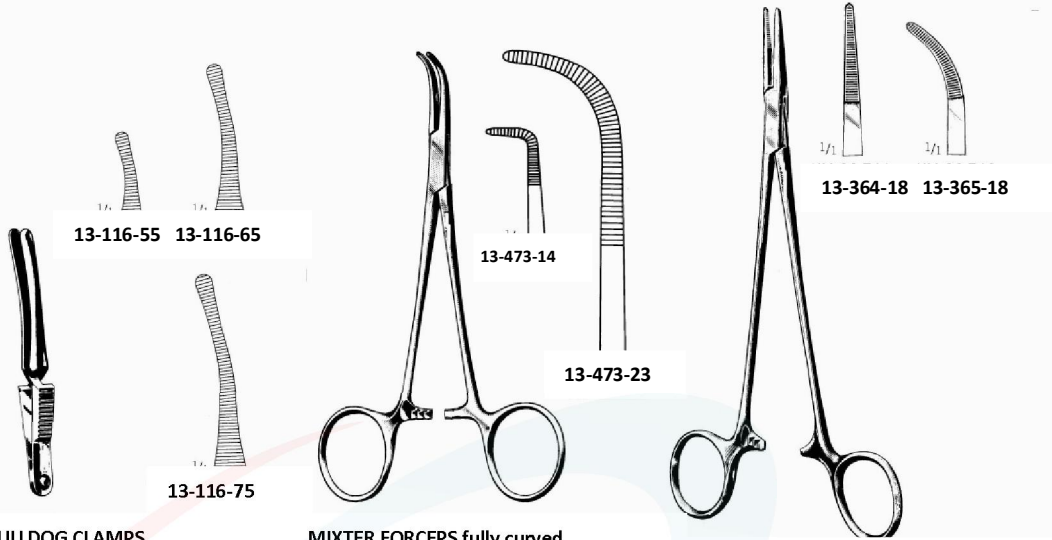

#### JOHNS HOPKINS BULLDOG CLAMPS

straight	curved
13-115-38 1 1/2"	13-116-38 1 1/2" (38mm)
13-115-55 2"	13-116-55 2" (51mm)
13-115-65 2 1/2"	13-116-65 2 1/2" (64mm)
13-115-75 3"	13-116-75 3" (76mm)
13-115-90 3 1/2"	13-116-90 3 1/2" (89mm)

#### MIXTER FORCEPS fully curved

13-473-14 5 1/4" (133mm) delicate
13-473-16 6 1/4" (159mm)
13-473-18 7 1/4" (184mm)
13-473-23 9" (229mm)

#### ADSON HEMOSTATIC FORCEPS

13-364-18 7 1/4" (184mm) straight	13-365-18 7 1/4" (184mm) curved
-----------------------------------	---------------------------------

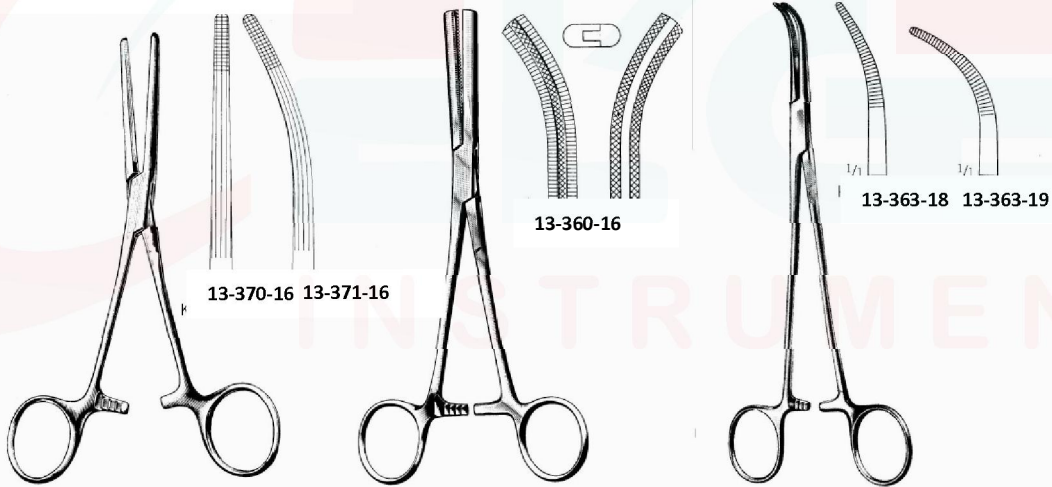

#### ROCHESTER-CARMALT FORCEPS

straight	curved
13-370-16 6 1/4"	13-371-16 6 1/4" (159mm)
13-370-20 8"	13-371-20 8" (203mm)

#### FERGUSON ANGIOTRIBE FORCEPS

straight	curved
13-360-16 6 1/2"	13-361-16 6 1/2" (165mm)
13-360-18 7 1/2"	13-360-18 7 1/2" (191mm)

#### SCHNIDT FORCEPS

13-363-18 7 1/2" (191mm) half curved	13-363-19 7 1/2" (191mm) full curved
--------------------------------------	--------------------------------------

## INTESTINAL FORCEPS

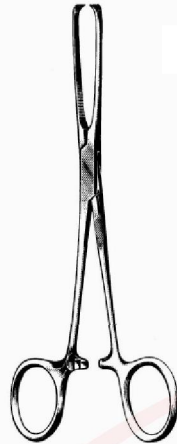

30-130-12

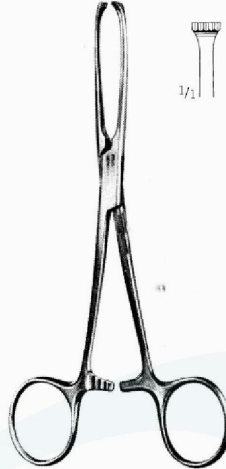

ALLIS TISSUE FORCEPS  
30-134-19  
7 1/2" (191mm) 5x6 teeth



ALLIS-JUDD TISSUE FORCEPS  
30-148-15  
6" (152mm) 3x4 teeth

### ALLIS TISSUE FORCEPS

- 30-130-12 4 3/4" (4x5 teeth delicate (121mm)
- 30-130-14 5 3/4" (4x5 teeth delicate (146mm)
- 30-128-15 6" (3x4 teeth standard (152mm)
- 30-130-15 6" (4x5 teeth standard (152mm)
- 30-134-15 6" (5x6 teeth standard (152mm)



30-192-16

### BABCOCK FORCEPS

- 30-192-16 6 3/4" (159mm)
- 30-192-20 8" (203mm)
- 30-192-24 9 1/2" (241mm)



LAHEY VULSELLUM FORCEPS  
27-449-15  
6 1/4" (159mm) 3x3 prongs



30-275-23

DOYEN CLAMP longitudinal serrations  
30-274-23 30-275-23  
9" (229mm) 9" (229mm)  
straight curved

**TUBING AND UTILITY FORCEPS**

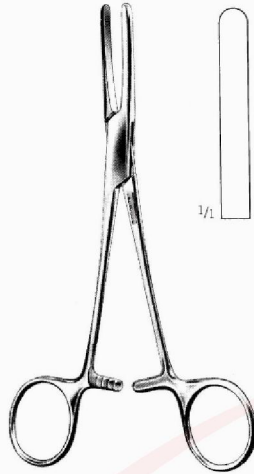

**PRESBYTERIAN TUBE  
OCCLUDING FORCEPS**  
13-942-16  
7" (178mm) smooth



13-944-18

**VORSE TUBE OCCLUDING FORCEPS**  
serrated  
13-944-15 5 1/2" (140mm)  
13-944-18 7 1/4" (184mm)  
13-944-20 8" (203mm)



13-946-18

**VORSE TUBE OCCLUDING FORCEPS**  
serrated, with guard  
13-946-14 5 1/2" (140mm)  
13-946-18 7 1/4" (184mm)  
13-946-20 8" (203mm)



19-301-20

19-301-24

**MAGILL ENDOTRACHEAL CATHETER INTRODUCING FORCEPS**  
19-301-20 7" (178mm) child  
19-301-24 9" (229mm) adult

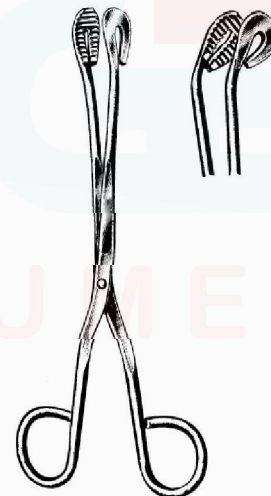

**UTILITY AND STERILIZER FORCEPS**  
straight curved  
55-094-20 8" 55-095-20 8" (203mm)  
55-094-27 11" 55-094-27 11" (279mm)

**TOWEL AND SPONGE FORCEPS**



**JONES TOWEL FORCEPS**  
 13-881-05      13-881-05  
 2 ½" (64mm)      3 ¼" (83mm)



**BACKHAUS TOWEL FORCEPS**  
 13-915-08      13-915-13  
 3 ½" (89mm)      5 ¼" (133mm)

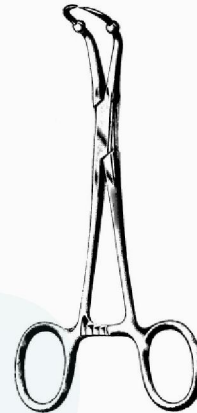

**BACKHAUS-ROEDER TOWEL CLAMP**  
 13-917-13  
 5 ¼" (133mm) with ball stops

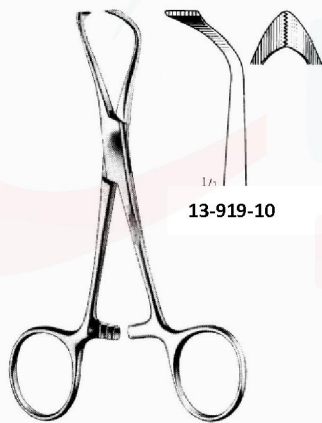

**LORNA (EDNA) TOWEL CLAMP**  
 13-919-10 13-919-13  
 4" (102mm)      5" (133mm)  
 non-perforating      non-perforating

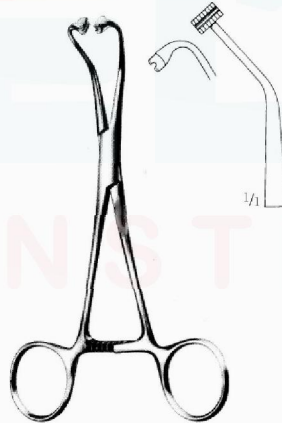

**PEERS TOWEL CLAMP**  
 13-916-15  
 5 ¾" (146mm)  
 non-perforating



**FOERSTER SPONGE FORCEPS**  
 straight, serrated      curved, serrated  
 14-352-18 7"      14-353-18 7" (178mm)  
 14-352-25 9 ¾"      14-353-25 9 ¾" (241mm)  
 straight, smooth      curved, smooth  
 14-353-18 7"      14-355-18 7" (178mm)  
 14-353-25 9 ¾"      14-355-25 9 ¾" (241mm)

## DRESSING AND TISSUE FORCEPS

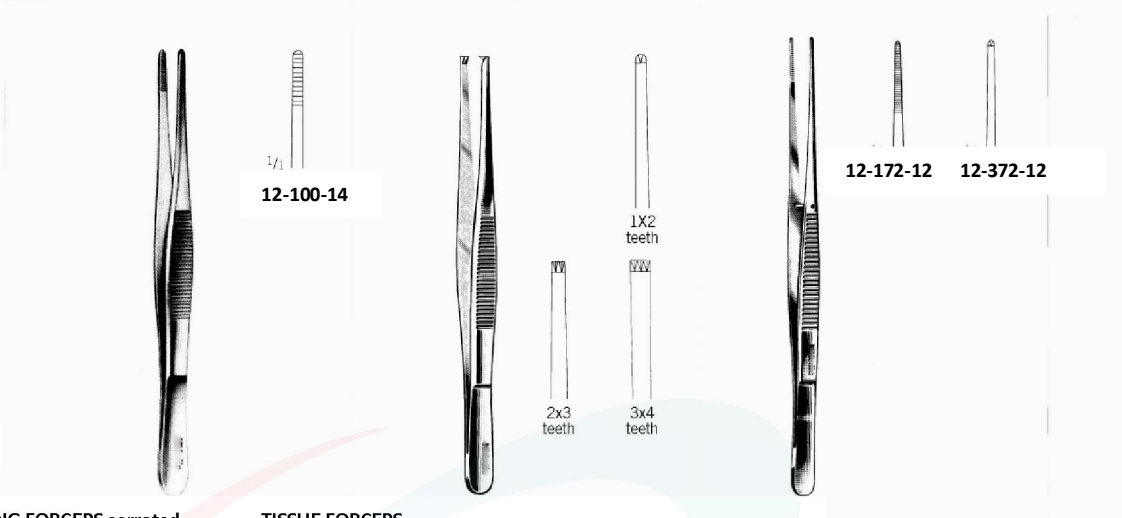

### DRESSING FORCEPS serrated

- 12-100-11 4 1/2" (114mm)
- 12-100-13 5" (127mm)
- 12-100-14 5 1/2" (140mm)
- 12-100-6 6" (152mm)
- 12-100-8 8" (203mm)
- 12-100-10 10" (254mm)
- 12-100-12 12" (305mm)

### TISSUE FORCEPS

- 1x2 teeth**
- 11-301-11 4 1/2" (114mm)
- 11-301-11 5" (127mm)
- 11-301-11 5 1/2" (140mm)
- 11-301-11 6" (152mm)
- 11-301-11 8" (203mm)
- 11-301-11 10" (254mm)
- 11-301-11 12" (305mm)

### 2x3 teeth

- 11-302-13 5" (127mm)
- 11-302-14 5 1/2" (140mm)

### 3x4 teeth

- 11-303-14 5 1/2" (140mm)

### SEMKEN FORCEPS

- serrated**
- 12-172-12 5" (127mm)
- 12-172-15 6" (152mm)
- 1x2 teeth**
- 12-372-12 5" (127mm)
- 12-372-15 6" (152mm)

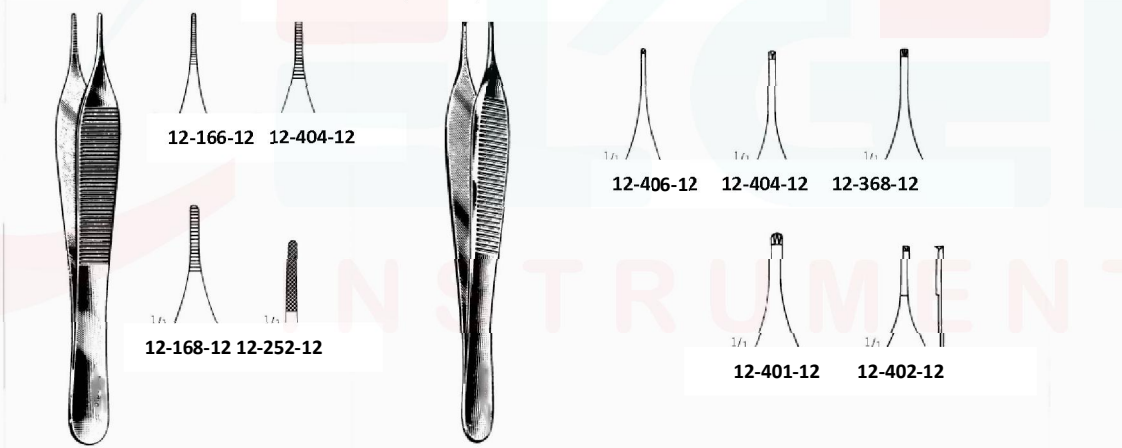

### ADSON DRESSING FORCEPS

- 4 3/4" (121mm) serrated
- 12-166-12 micro tip
- 12-404-12 delicate tip
- 12-168-12 standard tip
- 12-252-12 carbide tip

### ADSON TISSUE FORCEPS 4 3/4" (121mm)

- 1x2 teeth
- 12-406-12 micro tip
- 12-404-12 delicate tip
- 12-368-12 standard tip
- 12-402-12 delicate, with tying platform
- 2x3 teeth
- 12-401-12

## DRESSING AND TISSUE FORCEPS

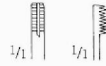

**ADSON BROWN TISSUE FORCEPS**  
 12-403-12  
 4 3/4" (121mm) 9x9 teeth  
 side grasping

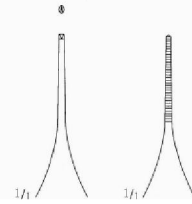

12-402-15 12-404-15

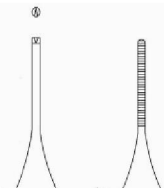

12-368-15 12-168-15

**ADSON DRESSING AND TISSUE FORCEPS 6" (152mm)**  
 12-402-15 micro 1x2 teeth  
 12-404-15 micro serrated  
 12-368-15 1x2 teeth  
 12-168-15 serrated



11-120-14

**DRESSING FORCEPS**  
 serrated with fluted handles  
 11-120-11 4 1/2" (114mm)  
 11-120-13 5" (127mm)  
 11-120-14 5 1/2" (140mm)  
 11-120-15 6" (152mm)



**TISSUE FORCEPS**  
 1x2 teeth with fluted handles  
 11-321-11 4 1/2" (114mm)  
 11-321-13 5" (127mm)  
 11-321-14 5 1/2" (140mm)  
 11-321-15 6" (152mm)

## DRESSING AND TISSUE FORCEPS

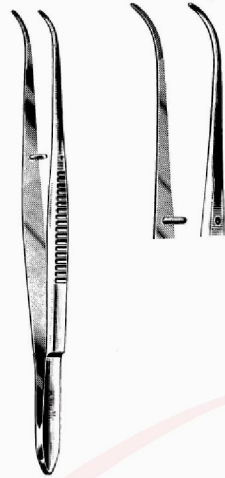

**DRESSING FORCEPS**  
 12-127-13  
 5" (127mm) curved  
 fine point serrated



12-420-15

**RUSSIAN TISSUE FORCEPS**  
 12-420-15 6" (152mm)  
 12-420-20 8" (203mm)  
 12-420-25 10" (254mm)

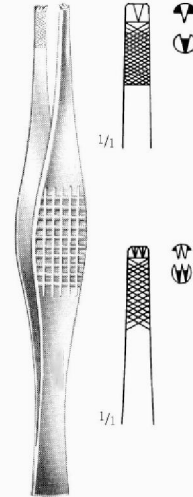

**FERRIS-SMITH TISSUE FORCEPS**  
 7" (178mm) with platform  
 12-451-18 1x2 teeth  
 12-452-18 2x3 teeth

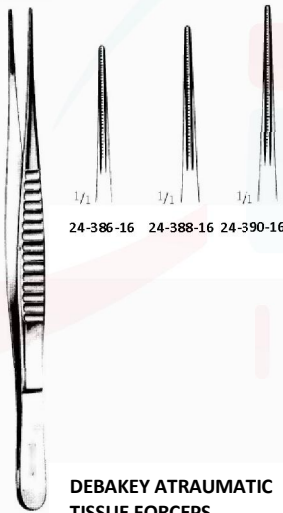

24-386-16 24-388-16 24-390-16

**DEBAKEY ATRAUMATIC  
 TISSUE FORCEPS**  
 24-386-16 6 1/4" (159mm) 1.5mm  
 24-386-20 8" (203mm) 1.5mm  
 24-386-24 9 1/4" (235mm) 1.5mm  
 24-388-16 6 1/4" (159mm) 2.0mm  
 24-388-20 8" (203mm) 2.0mm  
 24-388-24 9 1/4" (235mm) 2.0mm  
 24-390-16 6 1/4" (159mm) 3.5mm  
 24-390-20 8" (203mm) 3.5mm  
 24-390-24 9 1/4" (235mm) 3.5mm



**ADSON BAYONET FORCEPS**  
 12-178-21  
 8 1/4" (210mm) straight  
 with serrated tips



**CUSHING BAYONET  
 TISSUE FORCEPS 7 1/4" (184mm)**  
 12-383-17 1x2 teeth  
 12-183-17 serrated



### DRESSING AND TISSUE FORCEPS

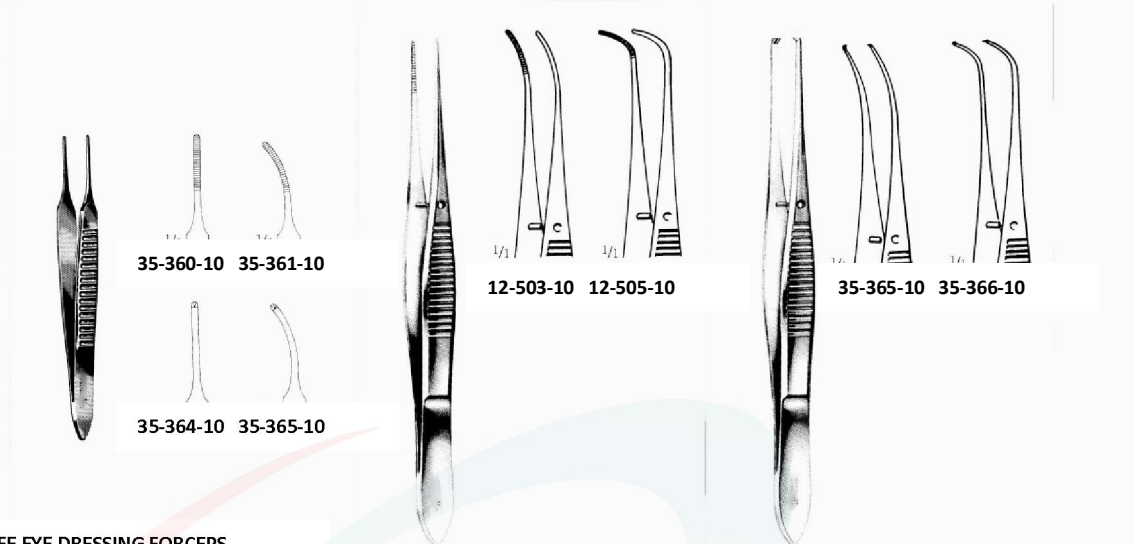

#### GRAEFE EYE DRESSING FORCEPS

2 1/2' (64mm)  
 35-360-10 straight serrated  
 35-361-10 curved serrated  
 35-364-10 straight 1x2 teeth  
 35-365-10 curved 1x2 teeth

EYE DRESSING FORCEPS 4" (102mm)  
 serrated  
 12-502-10 straight  
 12-503-10 half curved  
 12-505-10 full curved

IRIS FORCEPS 4" (102mm)  
 1x2 teeth  
 35-364-10 straight  
 35-365-10 half curved  
 35-366-10 full curved

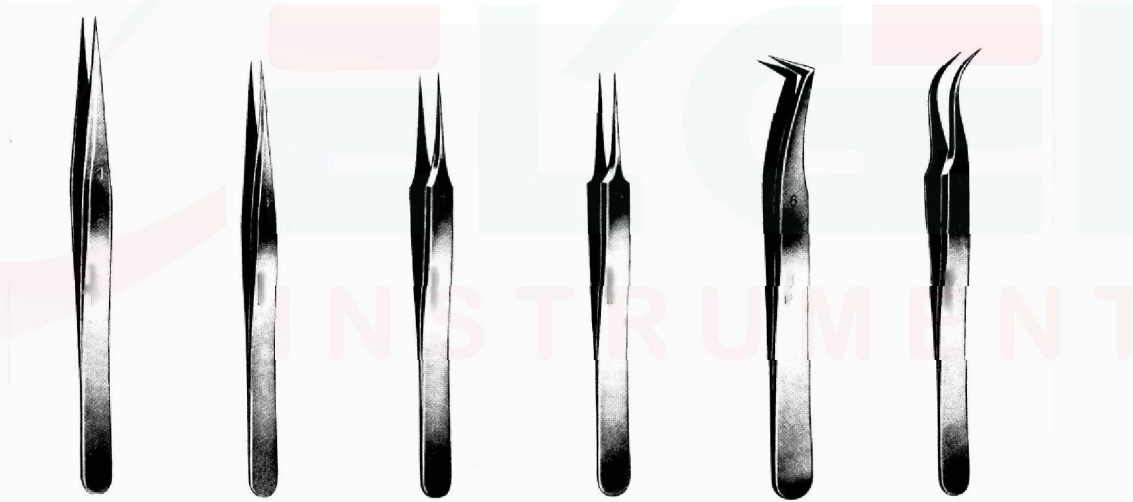

12-410-12  
 #3  
 4 3/4" (121 mm)

12-412-11  
 #3C  
 4 3/4" (121 mm)

12-416-11  
 #4  
 4 3/4" (121 mm)

12-414-11  
 #5  
 4 3/4" (121 mm)

12-413-11  
 #6  
 4 3/4" (121 mm)

12-409-12  
 #7  
 4 3/4" (121 mm)

#### SWISS JEWELERS STYLE FORCEPS

**SPLINTER FORCEPS**



12-630-07

**FEILCHENFELD FORCEPS serrated**  
12-630-07  
3 1/2" (83mm)



12-601-07

**PLAIN SPLINTER FORCEPS serrated**  
12-601-07  
3 1/2" (89mm)



12-640-10



12-641-10

**CARMALT SPLINTER FORCEPS serrated**  
12-640-10  
4 1/4" (108mm)  
Straight

12-641-10  
4 1/2" (108mm)  
curved



**VIRTUS SPLINTER FORCEPS**  
12-740-15  
6" (152mm) straight  
serrated



**VANGUARD SPLINTER LIBERATOR**  
12-744-12  
5" (127mm), trocar in trocar point only  
reversible handle



12-720-13



12-721-13

**WILLIAMS SPLINTER FORCEPS serrated**  
12-720-13 5 1/2" (140mm) straight  
12-721-13 5 1/2" (133mm) 45 degree angled  
12-722-13 5 1/2" (140mm) 90 degree angled

## NEEDLE HOLDERS

Our carbide needle holders have TC inserts firmly bonded to the inside of both jaws. We guarantee them for three years. The surface profiles of the inserts have been precision milled to provide the surgeon with a firm, non-slip grip on the needle. Because the carbide is harder than the steel of the needles, carbide needle holders last much longer than ordinary ones. The finger rings are gold plated for easy identification.

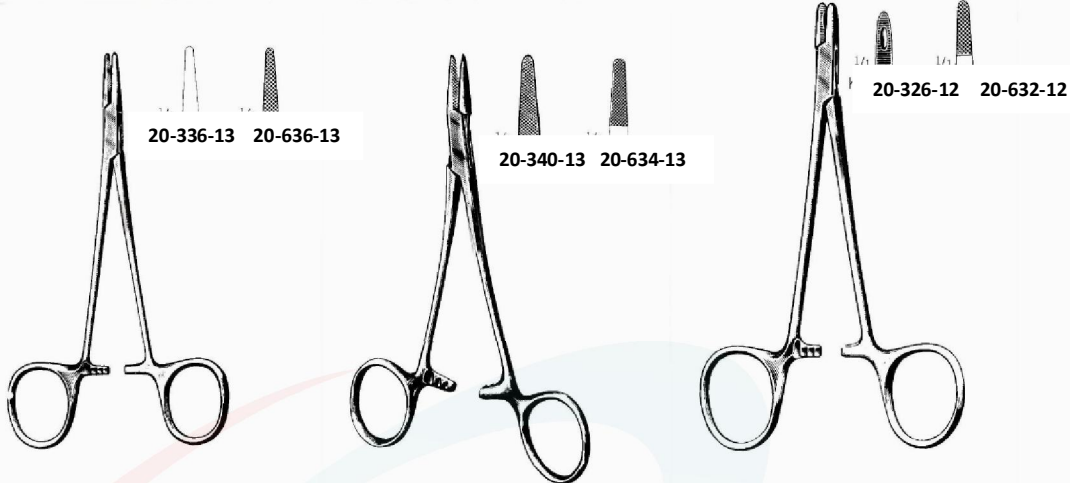

**HALSEY NEEDLE HOLDER**  
 20-336-13 5" (127mm) smooth  
 20-636-13 5" (127mm) smooth carbide  
 20-336-13 5 1/4" (133mm) serrated  
 20-637-13 5" (127mm) serrated carbide

**HEGAR BAUMGARTNER NEEDLE HOLDER**  
 20-340-13 5" (127mm) serrated  
 20-340-14 5 3/4" (146mm) serrated  
 20-634-13 5" (127mm) serrated carbide

**DERF NEEDLE HOLDER**  
 20-326-12 4 3/4" (121mm) horizontal serrations  
 20-632-12 4 3/4" (121mm) carbide cross serrations



**WEBSTER NEEDLE HOLDER** smooth  
 20-334-13 5" (127mm)  
 20-637-12 5" (127mm) carbide

**COLLIER NEEDLE HOLDER**  
 20-332-12 5" (127mm) fenestrated jaws serrated

**NIEVERT NEEDLE HOLDER** smooth, one offset inger ring  
 20-338-13 5" (127mm)  
 20-635-13 5" (127mm) carbide

## NEEDLE HOLDERS

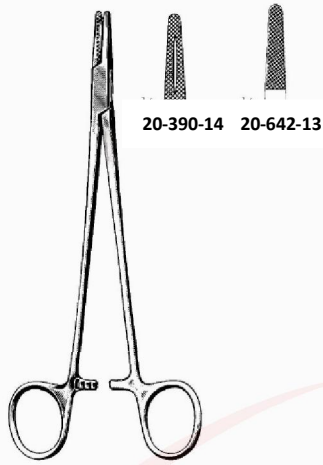

20-390-14 20-642-13

### MAYO HEGAR NEEDLE HOLDER serrated

20-390-14 5 1/4" (133mm)	carbide	20-642-13 5" (127mm)
20-390-15 6"		20-642-15 6" (152mm)
20-390-18 7"		20-642-18 7" (178mm)
20-390-20 8"		20-642-20 8" (203mm)
20-390-26 10 1/2"		20-642-26 10 1/2" (267mm)

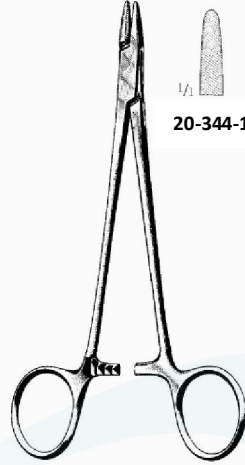

20-344-13

### BROWN NEEDLE HOLDER fine serrations

20-344-13 5 1/4" (133mm)	convex jaws	20-344-18 7 1/4" (184mm)	convex jaws
--------------------------	-------------	--------------------------	-------------

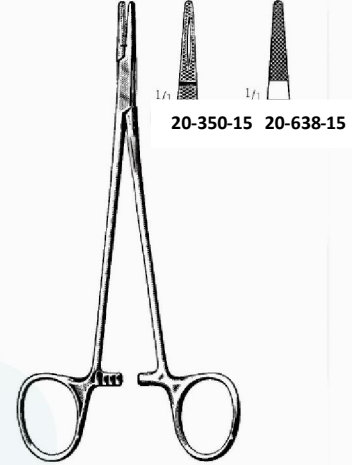

20-350-15 20-638-15

### CRILE-WOOD (DEBAKEY) NEEDLE HOLDER

serrated	carbide
20-350-15 6"	20-638-15 6" (152mm)
20-350-18 7"	20-638-18 7" (178mm)
20-350-20 8"	20-638-20 8" (203mm)
20-350-23 9"	20-638-23 9" (229mm)

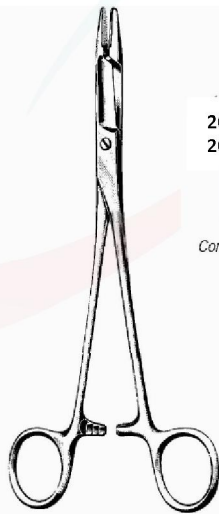

**OLSEN-HEGAR NEEDLE HOLDER**

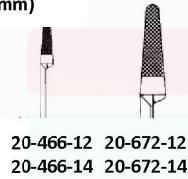

20-466-12 20-672-12  
20-466-14 20-672-14

Combination needle holder and suture scissors.

20-466-12 4 3/4" (121mm) delicate serrated*
20-467-12 4 3/4" (121mm) delicate smooth*
20-466-14 5 1/2" (140mm) serrated
20-466-16 6 1/2" (165mm) serrated
20-466-19 7 1/2" (191mm) serrated
carbide
20-672-12 4 3/4" (121mm) delicate serrated*
20-673-12 4 3/4" (121mm) delicate smooth*
20-672-14 5 1/2" (140mm) serrated
20-672-16 6 1/2" (165mm) serrated
20-672-19 7 1/2" (191mm) serrated

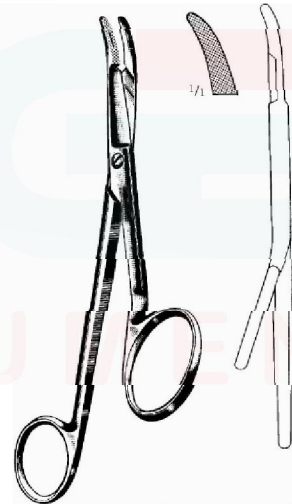

Combination needle holder and suture scissors.

### GILLIES NEEDLE HOLDER

20-469-16 6 1/2" (165mm) curved one fenestrated jaw one angled finger ring
--

## NEEDLE HOLDERS

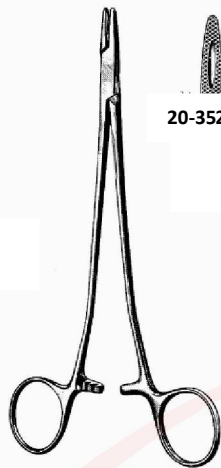

20-352-18



20-654-13



20-652-13

**SAROT NEEDLE HOLDER serrated carbide**  
 20-352-18 7 1/2" (191mm)  
 20-352-26 10 1/2" (267mm)

**RYDER NEEDLE HOLDER serrated carbide**  
 20-654-13 5" (127mm) 20-654-20 8" (203mm)  
 20-654-15 6" (152mm) 20-654-23 9" (229mm)  
 20-654-18 7" (178mm) 20-654-26 10 1/2" (260mm)

**RYDER MICRO NEEDLE HOLDER serrated carbide**  
 20-652-13 5" (127mm) 20-652-20 8" (203mm)  
 20-652-15 6" (152mm) 20-652-23 9" (229mm)  
 20-652-18 7" (178mm)



20-516-14



20-306-14 20-307-14



20-304-01 20-305-01

**MATHIEU NEEDLE HOLDER serrated**  
 20-516-14 5 1/2" (140mm)  
 20-674-14 5 1/2" (140mm) carbide

**CASTROVIEJO MICRO NEEDLE HOLDER 5 1/2 (140mm) smooth, with lock carbide**  
 20-306-14 straight  
 20-307-14 curved  
 20-620-00 straight  
 20-620-01 curved

**CASTROVIEJO MICRO NEEDLE HOLDER 5 1/2 (140mm) extra delicate, smooth, with lock**  
 20-304-01 straight  
 20-305-01 curved

## SKIN HOOKS



**PRIMAX SKIN HOOK**  
15-010-12  
4 ¾" (121mm) one sharp prong  
2mm diameter

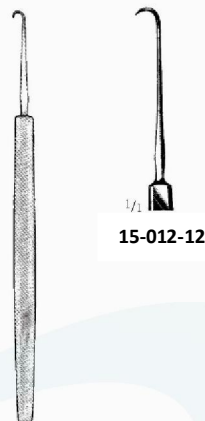

**WIENER SKIN HOOK 5" (127mm)**  
15-012-12 15-013-12  
one sharp prong    one blunt prong  
3.5mm diameter    3.5mm diameter

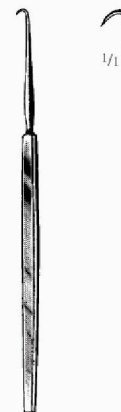

**COTTLE SKIN HOOK**  
37-686-03  
5 ½" (140mm) one sharp prong  
large deep curve 4mm diameter



**FRAZIER HOOK 5" (127mm)**  
24-835-13 24-835-18  
one sharp prong    one blunt prong  
2.5mm diameter    2.5mm diameter

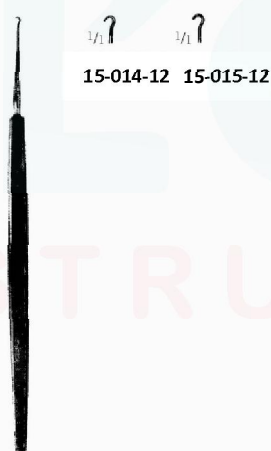

**TYRELL HOOK 5" (127mm)**  
15-014-12 15-015-12  
one sharp prong    one blunt prong  
1.5mm diameter    1.5mm diameter

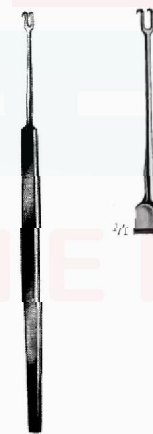

**GUTHRIE HOOK**  
15-072-02  
5" (127mm) 2 sharp prongs  
2.5mm wide

### SKIN HOOKS AND FINGER RETRACTORS

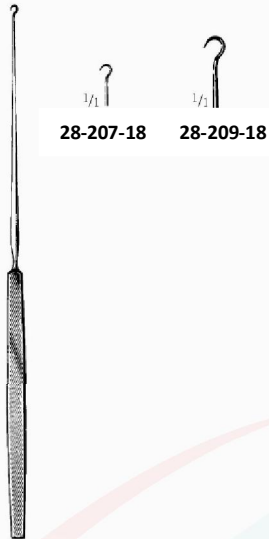

28-207-18 28-209-18



**FREER SKIN HOOK 6" (152mm)**  
37-702-15 37-703-15  
2 sharp prongs 2 blunt prongs  
2mm wide 2mm wide



15-068-03 15-068-05

**KLEINERT-KUTZ HOOK 6" (152mm)**  
15-068-03 3mm diameter  
15-068-05 5mm diameter  
15-068-07 7mm diameter

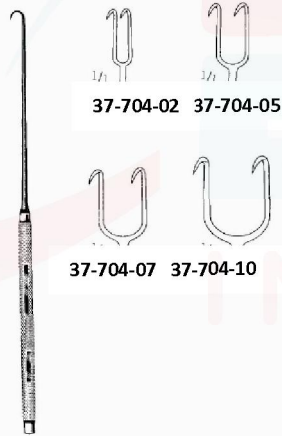

37-704-02 37-704-05

37-704-07 37-704-10

**JOSEPH HOOK 6 1/4" (159mm) sharp**  
37-704-01 1 prong  
37-704-02 2 prongs 2mm wide  
37-704-05 2 prongs 5mm wide  
37-704-07 2 prongs 7mm wide  
37-704-10 2 prongs 10mm wide

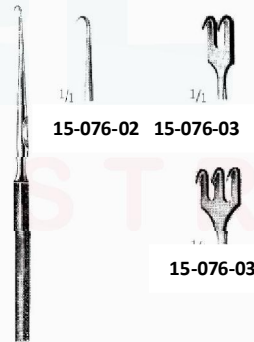

15-076-02 15-076-03

15-076-03

**LAHEY RETRACTOR 4 1/4" (121mm)**  
15-076-01 1 sharp prong  
15-076-02 2 sharp prongs  
15-076-03 3 sharp prongs

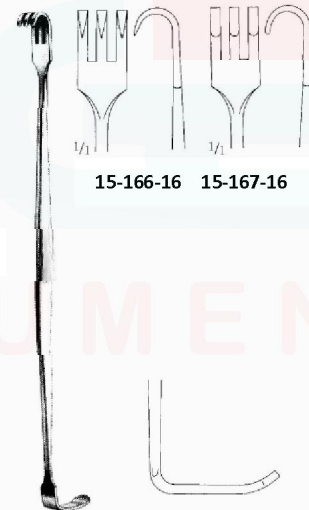

15-166-16 15-167-16

**SENN RETRACTOR 3 prongs**  
15-166-16 15-167-16  
6 1/4" (159mm) 6 1/4" (159mm)  
sharp blunt

## FINGER RETRACTORS



**BLAIR (ROLLET) RETRACTOR**  
 5 1/2" (140mm)  
 15-074-01 4 sharp prongs, rigid  
 15-075-01 4 blunt prongs, rigid  
 15-076-01 4 sharp prongs, flexible

**RIGID RAKE RETRACTOR 6 1/2" (165mm)**  
 15-080-01 1 sharp prong  
 15-080-02 2 sharp prongs  
 15-080-03 3 sharp prongs  
 15-081-03 1 blunt prong  
 15-081-03 2 blunt prongs  
 15-081-03 3 blunt prongs

**FLEXIBLE RAKE RETRACTOR 6 1/4" (159mm)**  
 15-078-01 1 sharp prong  
 15-078-02 2 sharp prongs  
 15-078-03 3 sharp prongs  
 15-079-01 1 blunt prong  
 15-079-02 2 blunt prongs  
 15-079-03 3 blunt prongs



*Fine cross serrations help prevent slippage.*

**RAGNELL RETRACTOR**  
 15-163-16  
 5 3/4" (146mm) double ended  
 4mm width x 8mm depth blade  
 and 6mm width x 15mm depth blade

**RAGNELL RETRACTOR**  
 15-164-16  
 5 3/4" (146mm) double ended WITH serrations  
 4mm width x 8mm depth blade  
 and 6mm width x 15mm depth blade

**DAVIS RETRACTOR**  
 15-165-16  
 6" (152mm) double ended  
 6mm width x 17mm depth blade  
 and 9mm width x 20mm depth blade



## RETRACTORS

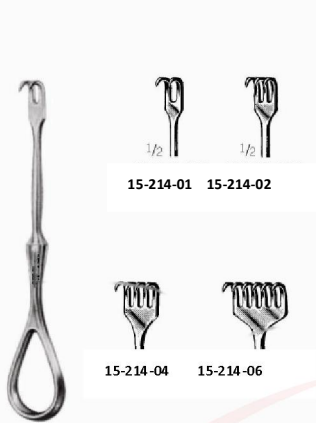

**VOLKMAN RETRACTOR 4 1/2" (114mm)**  
sharp  
15-214-01 1 prong  
15-214-02 2 prongs  
15-214-03 3 prongs  
15-214-04 4 prongs  
15-214-06 6 prongs  
blunt  
15-216-01 2 prongs  
15-216-03 3 prongs  
15-216-06 6 prongs



**VOLKMAN RETRACTOR 8 1/2" (216mm) with ring handle**

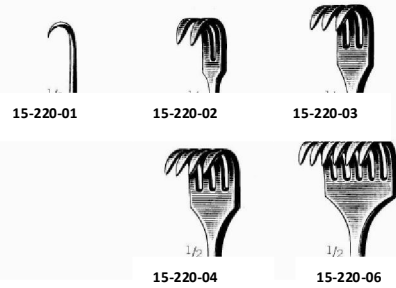

sharp  
15-220-01 1 prong 10mm depth  
15-220-02 2 prongs 8mm width X 10mm depth  
15-220-03 3 prongs 13mm width X 10mm depth  
15-220-04 4 prongs 18mm width X 10mm depth  
15-220-06 6 prongs 28mm width X 10mm depth  
blunt  
15-222-01 2 prongs 8mm width X 10mm depth  
15-222-03 3 prongs 13mm width X 10mm depth  
15-222-04 4 prongs 18mm width X 10mm depth  
15-222-06 6 prongs 28mm width X 10mm depth

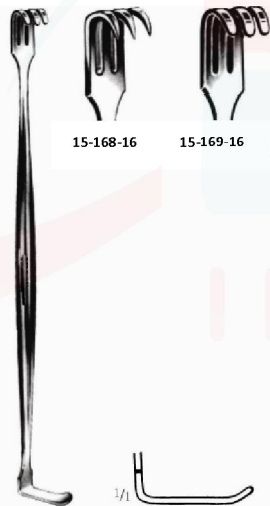

**MATHIEU RETRACTOR 6 1/2" (159mm)**  
15-168-16 3 sharp prongs  
15-169-16 3 blunt prongs



**JACKSON TRACHEAL HOOK**  
27-157-14  
5 3/4" (146mm) sharp

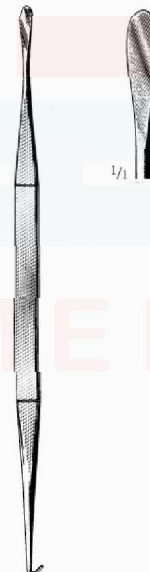

**SMITHWICK HOOK AND DISSECTOR**  
24-780-12  
12" (305mm) double ended

**RETRACTORS**



**CRILE RETRACTOR**  
15-154-11  
4 3/8" (111mm) double ended



**MEYERDING FINGER RETRACTOR 7" (178mm)**

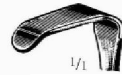

15-151-01  
#1



15-151-02  
#2



15-151-03  
#3



15-151-04  
#4



15-151-05  
#5



15-151-06  
#6



**LAHEY RETRACTOR**  
15-307-19  
7 3/4" (195mm)



**LITTLE RETRACTOR**  
15-313-20  
7 3/4" (195mm)



**LOVE NERVE RETRACTOR 8 1/2" (216mm)**  
24-694-19 7mm blade straight  
24-695-19 7mm blade angled 45 degrees  
24-697-19 7mm blade angled 90 degrees



24-694-19

**RETRACTORS**



**GREEN RETRACTOR**  
15-093-12  
8 ½" (216mm) fenestrated handle



**GOELET RETRACTOR**  
15-695-00  
7 ½" (191mm) double ended

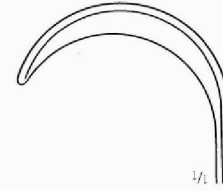

**CUSHING VEIN RETRACTOR**  
15-172-08  
9" (229mm) fenestrated handle



**CUSHING VEIN RETRACTOR**  
15-171-10  
8" (203mm) 10mm blade



15-291-01  
#1  
3/8" x 1 ¼"  
(10 x 32mm)

15-291-02  
#2  
3/8" x 1 ¼"  
(10 x 38mm)



15-291-03  
#3  
3/8" x 1 ¼"  
(13 x 38mm)



15-291-04  
#4  
3/8" x 1 ¼"  
(16 x 38mm)

**LANGENBECK RETRACTOR 8<sup>2</sup> (203mm)**

**RETRACTORS**



15-391-01

**RICHARDSON RETRACTOR 9 1/2" (241mm)**  
**15-391-01** 3/4" wide x 1" long blade  
 (19mm wide x 25mm long blade)  
**15-391-02** 1" wide x 1 1/4" long blade  
 (25mm wide x 32mm long blade)  
**15-391-03** 1 1/2" wide x 1 1/2" long blade  
 (38mm wide x 38mm long blade)

**RICHARDSON RETRACTOR**  
**15-395-24**  
 9 1/2" (241mm)  
 3/4" wide x 2" long blade  
 (19mm wide x 51mm long blade)

**RICHARDSON-EASTMANN**  
**RETRACTOR**  
**15-381-01** 9 1/2" (241mm) small  
**15-381-02** 10 1/4" (260mm) large  
**15-381-03** set of two

## RETRACTORS

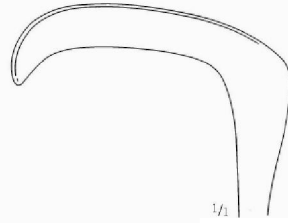

15-397-26

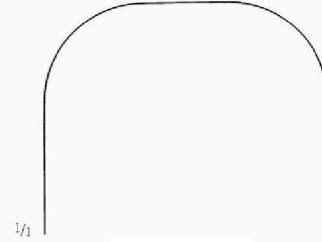

15-391-03



### KELLY RETRACTOR 93/4<sup>2</sup> (248mm) with loop handle

- 15-397-25 1 ½" x 2" blade (38mm x 51mm)
- 15-397-26 2" x 2 ½" blade (51mm x 64mm)
- 15-397-27 2 ½" x 3" blade (64mm x 76mm)
- 15-397-28 3" x 2 ½" blade (76mm x 64mm)

### DEAVER RETRACTOR hollow grip handle

- 15-391-01 1" wide x 10" long blade (25mm x 254mm)
- 15-391-02 1" wide x 12" long blade (25mm x 305mm)
- 15-391-03 1<sup>2</sup> wide x 13<sup>2</sup>" long blade (25mm x 330mm)
- 15-391-04 2<sup>2</sup> wide x 12<sup>2</sup>" long blade (51mm x 305mm)
- 15-391-05 2 ½" wide x 14 ½" long blade (64mm x 368mm)
- 15-391-06 3" wide x 12" long blade (76mm x 305mm)
- 15-391-07 3 ½" wide x 12" long blade (89mm x 305mm)

**RETRACTORS**

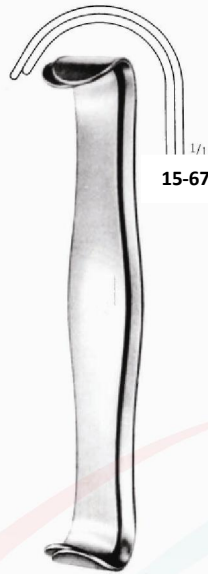

15-673-02

**PARKER RETRACTOR**  
double ended, set oft wo  
15-673-01 15-673-02  
5" (127mm) set      7 1/4" (184mm) set

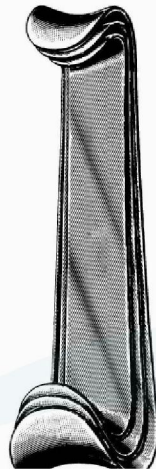

**ROUX RETRACTOR**  
15-655-01 5 1/4" (133mm) small  
3/4" x 1" (19mm x 25mm)  
15-655-02 5 3/4" (146mm) medium  
7/8" x 1 3/8" (22mm x 35mm)  
15-655-03 6 5/8" (173mm) large  
1" x 1 5/8" (25mm x 41mm)

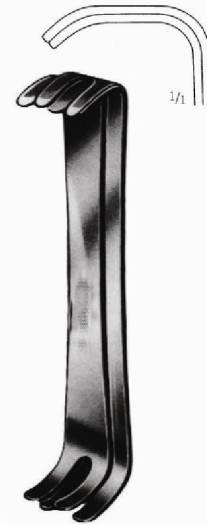

**MAYO-COLLINS RETRACTOR**  
15-680-15  
6" (152mm) double ended, set oft wo



**PARKER-MOTT RETRACTOR**  
15-675-00  
6" (152mm) double ended, set oft wo



**U.S. ARMY RETRACTOR**  
15-687-00  
8 1/4" (210mm) double ended, set oft wo



**RIBBON RETRACTOR malleable**  
15-975-13 6" x 1/2" (152mm x 13mm)  
15-975-25 7 1/2" x 1" (191mm x 25mm)  
15-975-19 13" x 3/4" (330mm x 19mm)  
15-976-25 13" x 1" (330mm x 25mm)  
15-975-32 13" x 1 1/4" (330mm x 32mm)  
15-975-38 13" x 1 1/2" (330mm x 38mm)  
15-975-51 13" x 2" (330mm x 51mm)

## SELF-RETAINING RETRACTORS

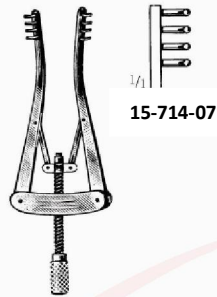

**ALM RETRACTOR** 4 blunt prongs  
 15-714-07 15-714-07  
 2 ¾" (70mm) 4" (102mm)



**SELF RETAINING RETRACTORS**  
 4" (102mm)  
 15-717-10 15-718-10  
 4 sharp prongs 4 blunt prongs

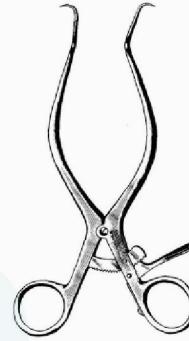

**GELPI RETRACTOR** sharp points  
 15-802-09 3 ½" (89mm)  
 15-802-11 4 ½" (114mm)  
 15-802-14 5 ½" (140mm)  
 15-802-18 7 ½" (191mm)  
 15-804-18 7" with ball stops (178mm)

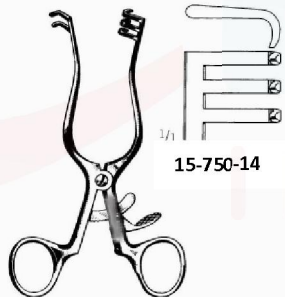

**WEITLANER RETRACTOR**

sharp points	blunt points
2x3 teeth	2x3 teeth
15-748-10 4"	15-749-10 4" (102mm)
3x4 teeth	3x4 teeth
15-750-14 5 ½"	15-751-14 5 ½" (140mm)
15-750-16 6 ½"	15-751-16 6 ½" (165mm)
15-735-20 8"	15-735-20 8" (203mm)
15-750-24 9 ½"	15-751-24 9 ½" (241mm)

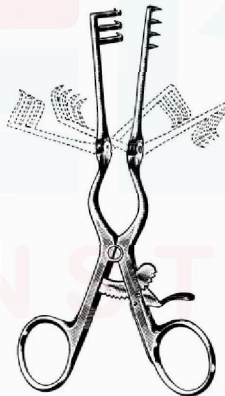

**BECKMAN-WEITLANER RETRACTOR** hinged blades

3x4 sharp prongs	
15-770-14 5 ½" (140mm)	15mm depth x 20mm height
15-770-16 6 ½" (165mm)	15mm depth x 20mm height
15-770-20 8 ½" (216mm)	17mm depth x 22mm height
15-770-24 9 ½" (241mm)	24mm depth x 22mm height
3x4 blunt prongs	
15-771-14 5 ½" (140mm)	15mm depth x 20mm height
15-771-16 6 ½" (165mm)	15mm depth x 20mm height
15-771-20 8 ½" (216mm)	17mm depth x 22mm height
15-771-24 9 ½" (241mm)	24mm depth x 22mm height

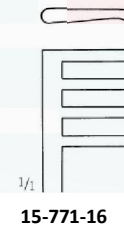
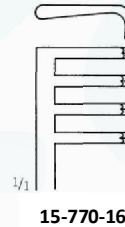

**SELF-RETAINING RETRACTORS**

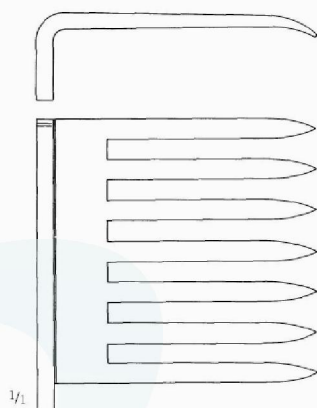

**BECKMAN-EATON RETRACTOR**  
15-776-31  
12 ½" (317mm)  
hinged blades  
7x7 sharp prongs  
45mm depth x 45mm height



**SELF-RETAINING RETRACTORS**

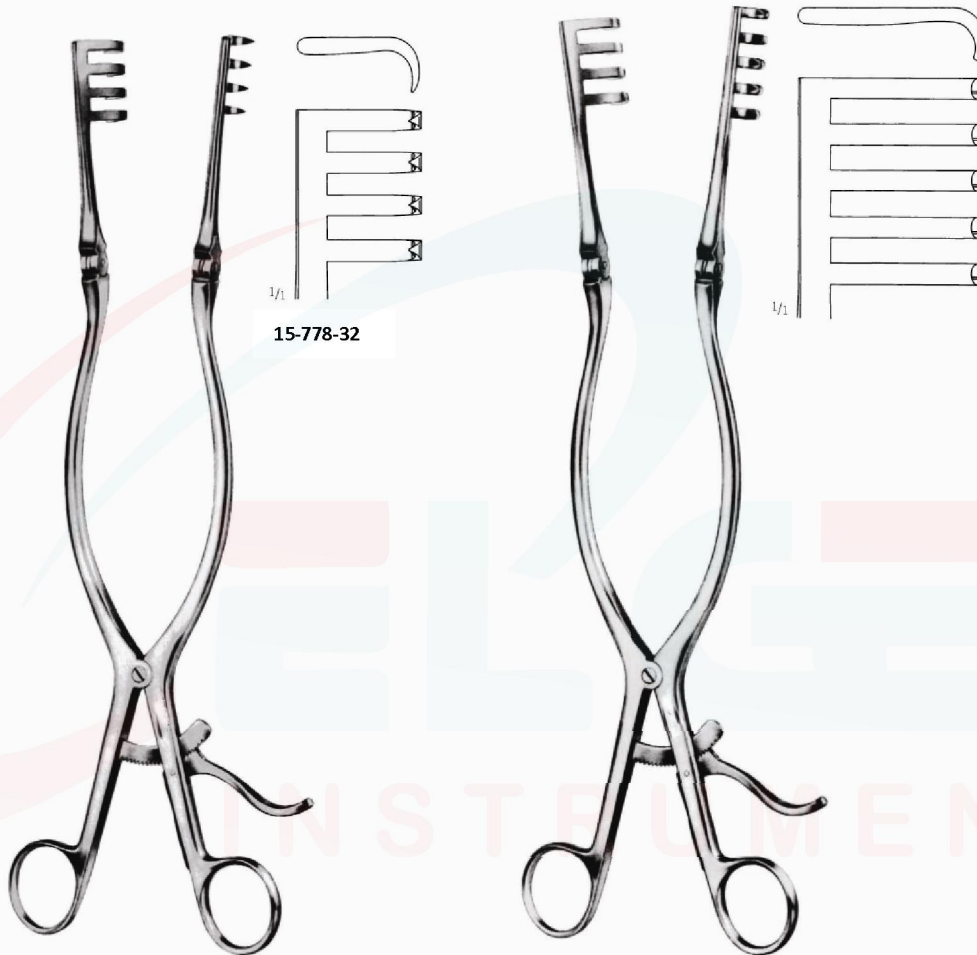

15-778-32

1/1

**BECKMAN RETRACTOR**

15-778-32	15-779-32
12 1/4" (311mm)	12 1/4" (311mm)
with hinged blades	with hinged blades
4x4 sharp prongs	4x4 blunt prongs
17mm depth x 27mm height	17mm depth x 27mm height

**ADSON RETRACTOR**

15-777-32
13" (330mm)
with hinged blades
4x5 blunt prongs

**RETRACTORS AND DILATORS**



**BALFOUR RETRACTOR Pediatric**  
15-850-00  
3 1/2" (89mm) spread, fenestrated

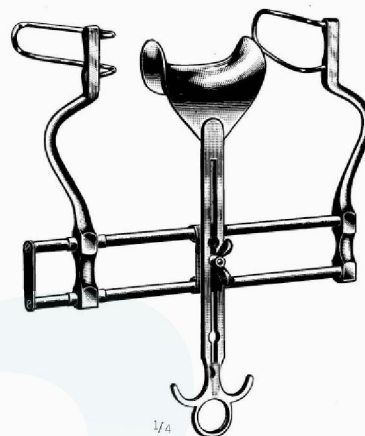

**BALFOUR RETRACTOR Adult**  
15-856-00  
7" (178mm) spread, fenestrated

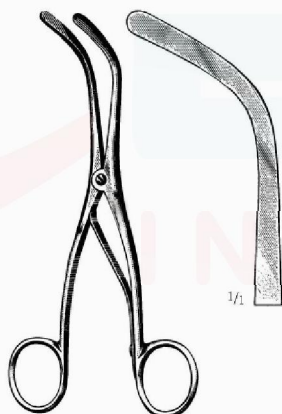

**TROSSEAU DILATOR**  
27-115-14  
5 1/4" (133mm) bi-valve

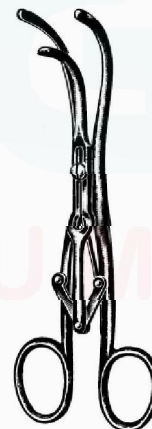

**LA BORDE DILATOR**  
27-113-14  
5 1/2" (140mm) tri-valve

## ELEVATORS



**FREER ELEVATOR**  
37-545-18  
7 1/2" (191mm) one sharp and  
one blunt blade, 5mm wide



37-521-04

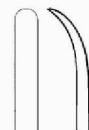

37-521-05

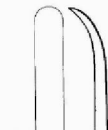

**MCKENTY ELEVATOR 5 1/2" (140mm)**  
37-521-04 37-521-05  
4mm wide 5mm wide



**KEY PERIOSTEAL ELEVATOR**  
23-402-06 7" (178mm) 1/4" (6mm) wide  
23-402-10 7 1/2" (191mm) 3/8" (10mm) wide  
23-402-13 7 1/2" (191mm) 1/2" (13mm) wide  
23-402-19 8" (203mm) 3/4" (19mm) wide  
23-402-25 8 1/4" (210mm) 1" (25mm) wide

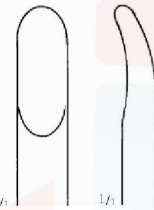

23-470-16

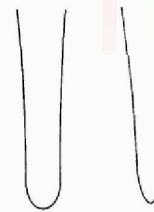

**SAYRE PERIOSTEAL ELEVATOR**  
6 1/2" (165mm)  
23-470-16  
sharp  
double ended  
23-471-16  
blunt  
double ended

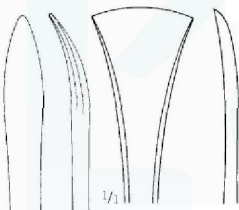

23-402-19

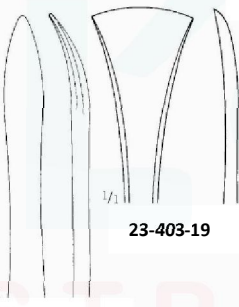

23-403-19

**LANGENBECK PERIOSTEAL ELEVATOR**  
7" (178mm)  
23-402-19 23-403-19  
7mm wide 18mm wide  
blunt edge sharp edge

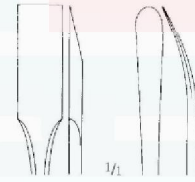

23-484-17 23-485-17

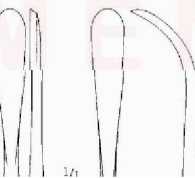

23-486-17 23-487-17

**ADSON PERIOSTEAL ELEVATOR**  
6  
ADSON PERIOSTEAL ELEVATOR  
2 6 3/4" (171mm)  
2 23-484-17 straight sharp  
2 23-485-17 curved blunt  
2 23-486-17 straight semi-sharp  
23-487-17 curved semi-sharp

## CURETTES



**MARTINI BONE CURETTE**  
23-358-00  
5 1/2" (140mm) double ended  
4mm and 5mm round cups



**WILLIGER BONE CURETTE**  
23-358-00  
5 1/2" (140mm) double ended  
3mm and 4mm oval cups



**VOLKMANN CURETTE**  
23-352-17  
6 1/2" (165mm) double ended  
oval cups



23-354-13 23-354-16

**VOLKMANN CURETTE oval and round cups**  
23-354-13 5" (127mm) double ended  
23-354-16 6 1/2" (165mm) double ended  
23-354-20 8" (203mm) double ended



**BRUN (SPRATT) CURETTE oval cup**

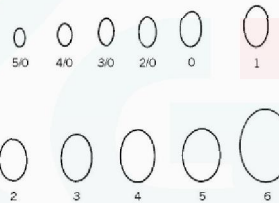

<b>7 (178mm)</b>	<b>9 (229mm)</b>
23-308-10 #5/0	23-334-10 #3/0
23-308-20 #4/0	23-334-20 #2/0
23-308-30 #3/0	23-334-30 #0
23-308-40 #2/0	23-335-01 #1
23-309-01 #0	23-335-02 #2
23-309-02 #1	23-335-03 #3
23-309-03 #2	23-335-04 #4
23-309-04 #3	23-335-05 #5
23-309-05 #4	23-335-06 #6
23-309-06 #5	
23-309-07 #6	

## OSTEOTOMES



**U.S. ARMY PATTERN OSTEOTOME**  
 6 1/2" (165mm)  
 23-118-06 6mm wide  
 23-118-12 12mm wide  
 23-118-18 18mm wide



**LAMBOTTE OSTEOTOME**

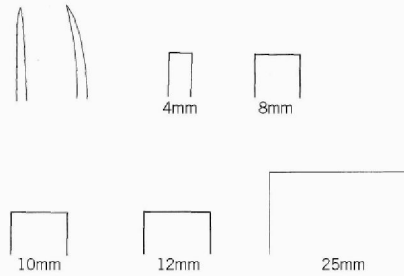

- 5" (127mm) straight without calibration lines  
 23-136-04 4mm  
 23-136-06 6mm  
 23-136-08 8mm  
 23-136-10 10mm  
 23-136-12 12mm  
 7" (178mm) straight with calibration lines  
 23-136-54 4mm  
 23-136-55 5mm  
 23-136-56 6mm  
 23-136-58 8mm  
 23-136-60 10mm  
 9" (229mm) straight without calibration lines  
 23-138-06 1/4" (6mm)  
 23-138-13 1/2" (13mm)  
 23-138-19 3/4" (19mm)  
 23-138-25 1" (25mm)  
 23-138-32 1 1/4" (32mm)  
 23-138-381 1/2" (38mm)  
 23-136-04 14mm  
 23-136-15 15mm  
 23-136-18 18mm  
 23-136-19 19mm  
 23-136-20 20mm  
 23-136-62 12mm  
 23-136-66 16mm  
 23-136-69 19mm  
 23-136-72 22mm  
 23-136-75 25mm  
 9" (229mm) curved without calibration lines  
 23-139-06 1/4" (6mm)  
 23-139-13 1/2" (13mm)  
 23-139-19 3/4" (19mm)  
 23-139-25 1" (25mm)  
 23-139-32 1 1/4" (32mm)  
 23-139-381 1/2" (38mm)



**SILVER OSTEOTOME**  
 7" (178mm) single guard  
 37-628-01 straight  
 37-628-02 guard, right  
 37-628-03 guard, left



- straight  
 23-162-03 1/8" (3mm)  
 23-162-04 3/16" (4mm)  
 23-162-06 1/4" (6mm)  
 23-162-08 5/16" (8mm)  
 23-162-10 3/8" (10mm)  
 23-162-13 1/2" (13mm)  
 23-162-16 5/8" (16mm)  
 23-162-19 3/4" (19mm)  
 curved  
 23-163-03 1/8" (3mm)  
 23-163-04 3/16" (4mm)  
 23-163-06 1/4" (6mm)  
 23-163-08 5/16" (8mm)  
 23-163-10 3/8" (10mm)  
 23-163-13 1/2" (13mm)  
 23-163-16 5/8" (16mm)  
 23-163-19 3/4" (19mm)

**HOKE OSTEOTOME**  
 5 1/4" (133mm)  
 straight

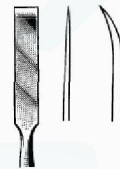

- 37-626-02 2mm  
 37-626-04 4mm  
 37-626-06 6mm  
 37-626-08 8mm  
 37-626-10 10mm  
 37-626-12 12mm  
 37-626-15 15mm

**SHEEHAN OSTEOTOME 6 1/4" (159mm)**

### BONE RASPS AND FILES

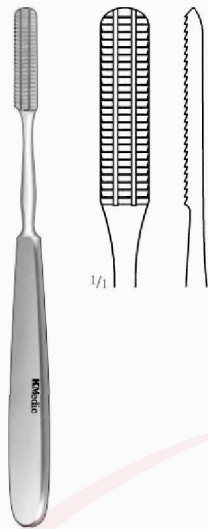

**MALTZ RASP**  
37-654-18  
7 ¼" (184mm)  
backward cutting

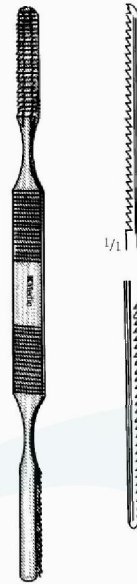

**MALTZ RASP IMPROVED**  
37-660-20 8 ½" (210mm) double ended  
forward and backward cutting

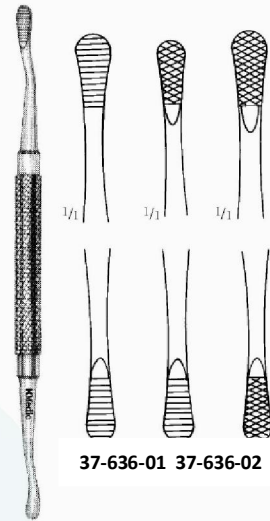

37-636-01 37-636-02 37-636-03

**BONE FILES 7" (178mm) double ended**  
37-636-01 #12 plain serrations  
37-636-02 #12A plain and cross serrations  
37-636-03 #12CA cross serrations

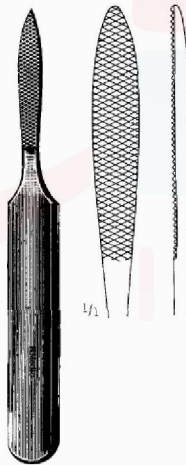

**JOSEPH RASP**  
37-658-02  
6 ¾" (159mm) fine  
cross serrations

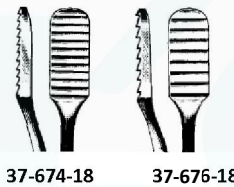

37-674-18

37-676-18

**LEWIS RASP backward cutting**  
37-674-18 7 ½" (191mm)  
fine teeth  
37-676-18 7 ½" (191mm)  
coarse teeth

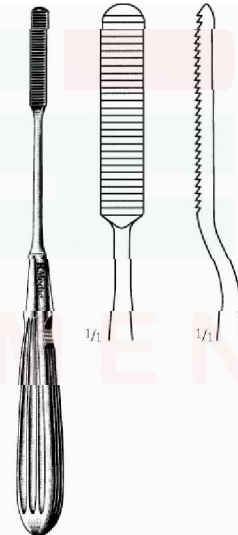

**COTTLE RASP**  
37-620-21  
8" (203mm)  
backward cutting

## BONE RASPS, FILES AND SAWS

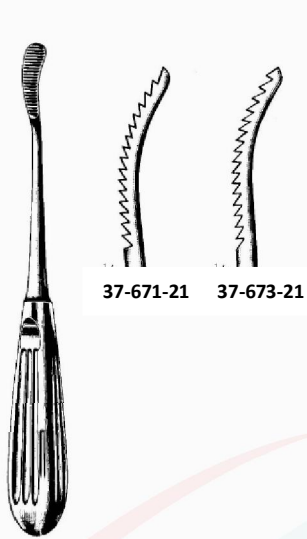

37-671-21 37-673-21

**AUFRICHT RASP 8 1/4" (210mm)**  
 37-671-21 forward cutting  
 37-673-21 backward cutting



**BONE FILE**  
 37-640-23  
 9 1/2" (241mm) bayonet shank  
 half round blade fine teeth

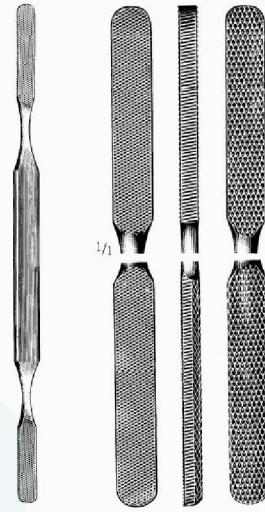

**FOMON RASP**  
 37-680-01  
 8 1/2" (216mm) double ended  
 fine and coarse teeth  
 4-sided, convex and flat



**PUTTI BONE RASP**  
 23-183-27  
 11" (279mm) flat ends  
 one end curved up  
 one end curved sideways



**PUTTI BONE RASP**  
 23-181-30  
 12" (305mm) one round end  
 and one half round end

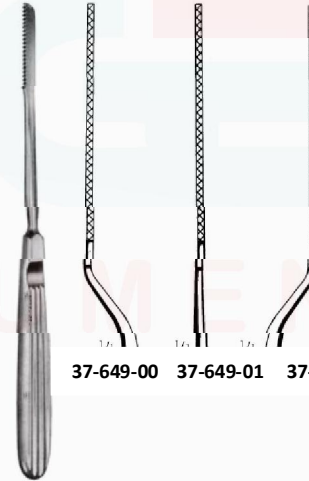

37-649-00 37-649-01 37-649-02

**JOSEPH BONE SAW 7 1/2" (191mm)**  
 37-649-00 straight  
 37-649-01 bayonet left  
 37-649-02 bayonet right

## DERMAL INSTRUMENTS



**SCHAMBERG COMEDONE EXTRACTOR**  
28-879-20  
3 ¾" (95mm)  
standard  
crimped loops



**SCHAMBERG COMEDONE EXTRACTOR**  
28-880-20  
3 ¾" (95mm)  
extra fine  
crimped loops



**SCHAMBERG COMEDONE EXTRACTOR**  
28-882-20  
3 ¾" (95mm)  
square loops



**UNNA COMEDONE EXTRACTOR**  
28-261-14  
5 ¾" (146mm)  
fenestrated spoon ends



**KATSCH COMEDONE EXTRACTOR**  
28-294-14  
6 ½" (159mm) one fenestrated cup  
and curved lancet with cap



**GREG COMEDONE EXTRACTOR**  
28-296-11  
5" (127mm) one fenestrated cup  
and lancet blade with cap



**SAALFELD COMEDONE EXTRACTOR**  
28-271-10  
4 ½" (114mm) with lancet  
and one fenestrated cup



## DERMAL INSTRUMENTS



**KEYES PUNCH 4" (102mm)**  
 28-240-02 2mm    28-240-05 5mm  
 28-240-03 3mm    28-240-06 6mm  
 28-240-04 4mm    28-240-08 8mm



**FOX CURETTE 5 1/2" (140mm) round**  
 28-188-01 1mm    28-188-04 4mm  
 28-188-02 2mm    28-188-05 5mm  
 28-188-03 3mm    28-188-06 6mm

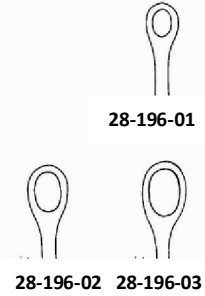

**PIFFARD CURETTE 5 1/2" (140mm) oval**  
 2 28-196-01 #1 small  
 2 28-196-02 #2 medium  
 28-196-03 #3 large

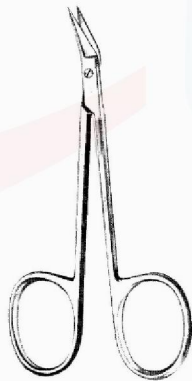

**BIRO DERMAL NAEVUS SCISSORS**  
 54-378-12  
 4" (102mm) angled on flat  
 sharp outside edges

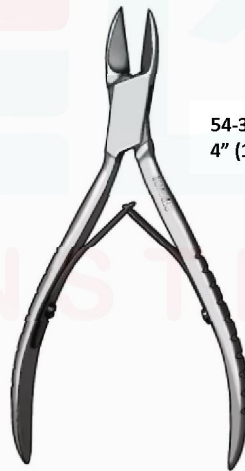

**NAIL SPLITTER**



54-360-10  
 4" (102mm)



54-360-11  
 4 1/2" (114mm)



54-362-13  
 5" (127mm)  
 heavy jaw



54-363-13  
 5" (127mm)  
 narrow jaw



54-360-11  
 6" (152mm)

*Note: For a sure grip, our  
 splitters have grooved handles.*

## DERMAL INSTRUMENTS

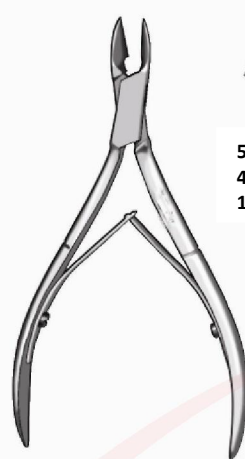

TISSUE NIPPER



54-365-11  
4 1/2" (114mm),  
11mm cutting edge



54-365-13  
5" (127mm)  
14mm  
cutting edge



NAIL NIPPER heavy



54-336-14  
5 1/2" (140mm)  
concave



54-337-14  
5 1/2" (140mm)  
straight



NAIL NIPPER  
54-341-11  
4 1/2" (114mm) concave  
chrome  
barrel spring



INGROWN NAIL FORCEPS  
54-368-13  
5" (127mm)  
14mm  
narrow blade



FINGER RING CUTTER  
23-972-16  
6 1/2" (165mm) chrome  
with saw blade

23-972-00  
saw blade only

## EYE INSTRUMENTS

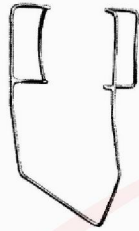

**BARRAQUER EYE SPECULUM**  
 1 3/4" (44mm)  
 34-110-03      34-110-04  
 small blades      large blades  
 10mm wide      15mm wide



**GRAEFE EYE SPECULUM**  
 34-220-09  
 3 1/2" (89mm)

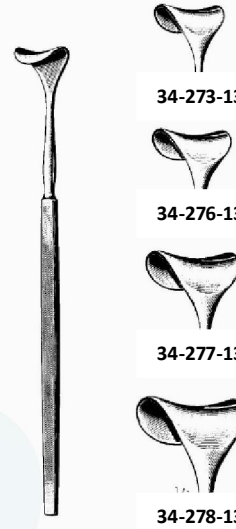

**DESMARRES LID RETRACTOR**  
 5 1/2" (140mm)  
 34-273-13 #1 11mm  
 34-276-13 #2 13mm  
 34-277-13 #3 15mm  
 34-278-13 #4 17mm



34-273-13



34-276-13



34-277-13



34-278-13

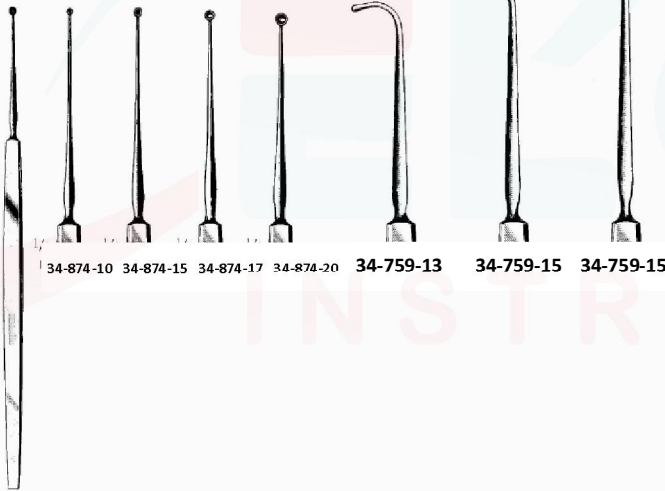

**MEYHOEFFER CURETTE 5" (127mm)**  
 34-874-10 #2/0 1.0mm  
 34-874-15 #0 1.5mm  
 34-874-17 #1 1.7mm  
 34-874-20 #2 2.0mm

**GRAEFE STRABISMUS HOOK**  
 5    GRAEFE STRABISMUS HOOK  
 3    5 1/2" 140mm  
 3    34-759-13 small  
 3    34-759-14 medium  
      34-759-15 large

**BOWMAN LACRIMAL PROBES**  
 5" (127mm) sterling

34-226-00 size 0000/000  
 34-226-01 size 00/0  
 34-226-12 size 1/2  
 34-226-34 size 3/4  
 34-226-56 size 5/6  
 34-226-78 size 7/8

**EYE INSTRUMENTS**

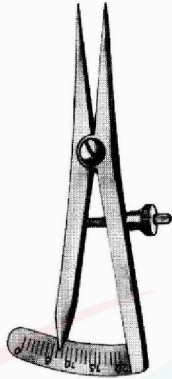

**CASTROVIEJO CALIPER**  
35-133-06  
3 ¼" (83mm) graduated  
0-15mm

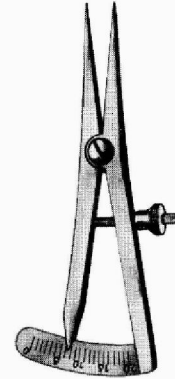

**CASTROVIEJO CALIPER**  
35-133-07  
3 ¼" (83mm) graduated  
0-20mm



**DIX SPUD AND NEEDLE**  
34-378-20  
in reversible screw handle



**FOREIGN BODY NEEDLES AND SPUDS**



**NEEDLE**  
34-370-01  
5" (127mm)  
2 x 5mm blade



**DAVIS**  
34-372-01  
4 ¼" (121mm)  
0.8mm blade



**ELLIS**  
34-374-01  
4 ½" (114mm) curved  
1.2mm blade

**EYE INSTRUMENTS**



**BISHOP HARMAN FORCEPS 3 3/8" (86mm)**  
 35-422-08 extra delicate serrated 0.7mm  
 35-426-08 delicate serrated 1.0mm  
 35-424-08 delicate 1x2 teeth 1.0mm



**TROUTMAN-BARRAQUER FORCEPS**  
 35-440-07  
 3" (76mm) 1x2 teeth  
 0.12mm with tying platform

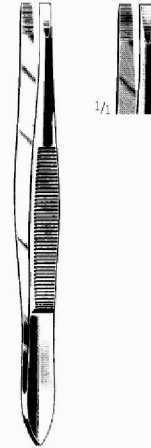

**DOUGLAS CILIA FORCEPS**  
 12-674-09  
 3 1/2" (89mm) fine serrations



**LITTAUER CILIA FORCEPS**  
 12-664-08  
 3 1/2" (89mm) fine serrations



**BERGH CILIA FORCEPS**  
 12-666-09  
 3 1/2" (89mm) fine serrations



**BARRAQUER CILIA & SUTURE FORCEPS**  
 12-695-10  
 4 1/2" (114mm) smooth platform



## EAR AND NOSE INSTRUMENTS

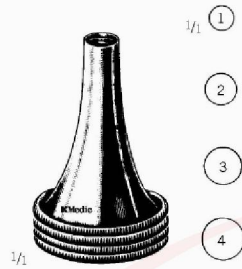

**HARTMAN EAR SPECULA round chrome**  
 36-112-11 #1 4mm diameter  
 36-112-12 #2 5mm diameter  
 36-112-13 #3 6mm diameter  
 36-112-14 #4 7mm diameter



**GRUBER EAR SPECULA oval adult chrome**  
 36-120-01 #1 4 x 5mm  
 36-120-02 #2 5 x 6mm  
 36-120-03 #3 6 x 7mm  
 36-120-04 #4 7 x 8mm

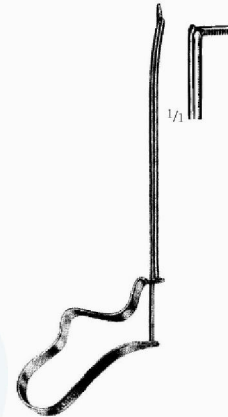

**QUIRE MECHANICAL FINGER**  
 36-418-10  
 4" (102mm)



**WILDE EAR FORCEPS**  
 36-371-11 4 1/2" (114mm) delicate serrated angular  
 36-381-13 5" (127mm) serrated angular



**LUCAS EAR FORCEPS**  
 36-391-14 5 1/2" (140mm) serrated bayonet

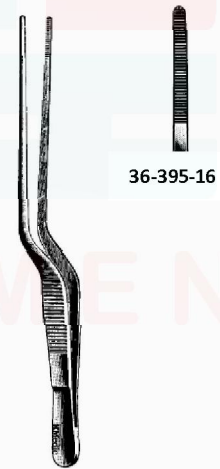

**JANSEN (GRUENWALD) EAR FORCEPS**  
 36-395-16 36-395-20 6 1/2" (159mm) serrated bayonet  
 8" (203mm) serrated bayonet

**EAR AND NOSE INSTRUMENTS**

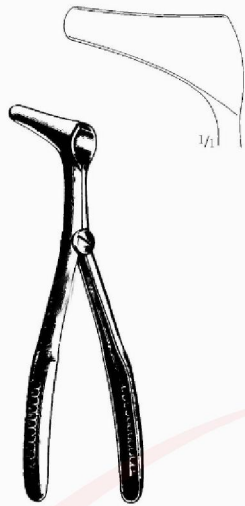

**VIENNA SPECULUM LIGHT**  
36-858-14  
5 3/4" (146mm)  
adult



**VIENNA SPECULUM 5 3/4" (146mm)**

**36-843-01**  
small

**36-843-02**  
medium

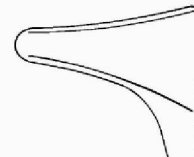

**36-843-03**  
large



**HALLE-TIECK SPECULUM**  
36-852-13      36-853-14  
5 1/2" (140mm)      5 1/2" (140mm)  
infant      adult



**36-852-13**



**KILLIAN NASAL SPECULUM 6" (152mm)**  
36-856-02 2" blade  
36-856-03 3" blade  
36-856-04 3 1/2" blade



**AUFRICHT NASAL RETRACTOR**  
37-697-19  
6 1/2" (165mm)  
solid blade

## EAR AND NOSE INSTRUMENTS

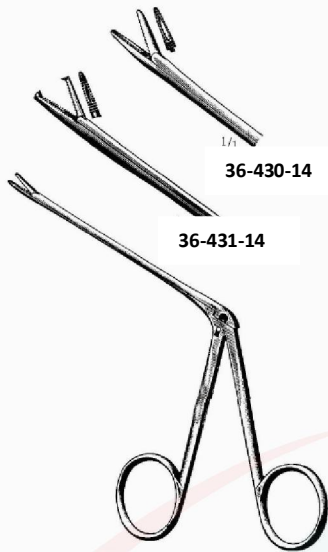

**HARTMANN ALLIGATOR FORCEPS**  
 36-430-08 3 1/2" (89mm) serrated  
 36-430-14 5 1/2" (140mm) serrated  
 36-430-16 6 1/2" (165mm) serrated  
 36-431-08 3 1/2" (89mm) 1x2 teeth serrated



**HARTMANN EAR DRESSING FORCEPS**  
 36-407-14  
 5" (127mm) delicate  
 serrated



**NOYES ALLIGATOR FORCEPS**  
 36-434-09 36-435-09  
 5 1/2" (140mm) 5 1/2" (140mm)  
 serrated 1x2 teeth  
 serrated

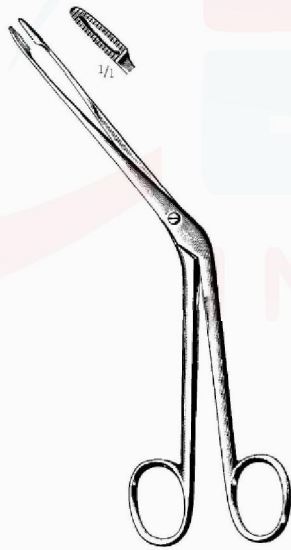

**HARTMANN NASAL FORCEPS**  
 37-143-20  
 8" (203mm) standard serrated

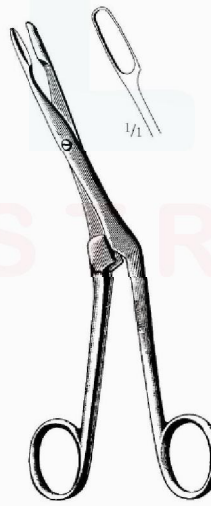

**KNIGHT SEPTUM FORCEPS**  
 37-207-18  
 7" (178mm)  
 cup jaws



**LUC SEPTUM FORCEPS 8" (203mm)**  
 37-215-01 37-215-02  
 small cup large cup



## EAR AND NOSE INSTRUMENTS



**GROSS SPOON AND HOOK**  
36-543-12  
4 3/4" (121mm)



**BILLEAU LOOP 6 1/2" (165mm)**



36-554-01  
#1 small

36-554-02  
#2 medium



36-554-03  
#3 large

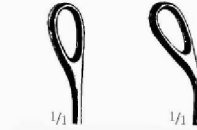

#1 36-747-01 #2 36-747-02



#3 36-747-03 #4 36-747-04



#5 36-747-05 #6 36-747-06

**COAKLEY ANTRUM CURETTES**  
6 3/4" (171mm)



**BUCK CURETTE 6 1/2" (165mm)**

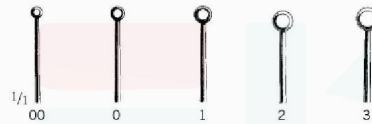

- straight blunt
- 36-495-02 #00
- 36-495-10 #0
- 36-495-11 #1
- 36-495-12 #2
- 36-495-13 #3
- angled blunt
- 36-497-02 #00
- 36-497-10 #0
- 36-497-11 #1
- 36-497-12 #2
- 36-497-13 #3
- straight sharp
- 36-496-02 #00
- 36-496-10 #0
- 36-496-11 #1
- 36-496-12 #2
- 36-496-13 #3
- angled sharp
- 36-498-02 #00
- 36-498-10 #0
- 36-498-11 #1
- 36-498-12 #2
- 36-498-13 #3

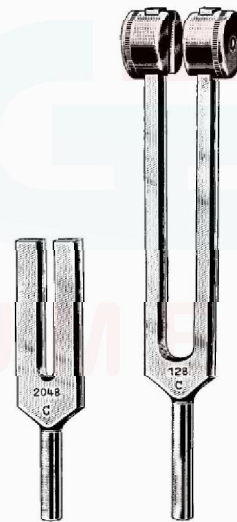

**TUNING FORK aluminum alloy**  
36-189-10 C-128  
36-192-11 C-256  
36-194-12 C-512  
36-196-13 C-1024  
36-198-14 C-2048  
36-200-00 set off in a case

**MALLETS**



**MALLET #49**  
23-215-19  
7 ¼" (195mm) lead filled and faced  
weight: 7 oz. (200 grams)  
head weight: 5 oz. (150 grams)  
head diameter: 22mm



*Autoclavable to  
250°F (121°C).*

**MEAD MALLET**  
23-220-17  
7 ½" (191mm) with replaceable nylon caps  
weight: 11 oz. (315 grams)  
head weight: 6 oz. (170 grams)  
head diameter: 20mm

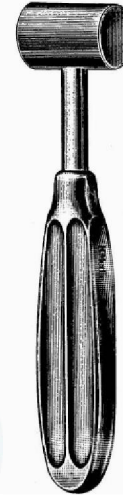

**GERZOG BONE MALLET**  
23-224-18  
7 ½" (191mm) lead filled and faced  
weight: 10 oz. (285 grams)  
head weight: 7 oz. (200 grams)  
head diameter: 25mm



**LUCAS BONE MALLET**  
23-200-01  
8" (203mm) brass head  
stainless steel handle  
weight: 9 oz. (260 grams)  
head weight: 5 oz. (150 grams)  
head diameter: 25mm



*Autoclavable to  
250°F (121°C).*

**MALLET lightweight**  
23-240-09  
7 ½" (191mm) with two replaceable nylon caps  
anodized aluminum handle  
weight: 7 oz. (200 grams)  
head weight: 4 oz. (120 grams)  
head diameter: 25mm



**HEATH MALLET heavyweight**  
23-215-19  
7 ½" (191mm) solid stainless steel  
weight: 2 lbs. (900 grams)  
head weight: 1 lb. 4 oz. (570 grams)  
head diameter: 40mm

## BONE CUTTING INSTRUMENTS

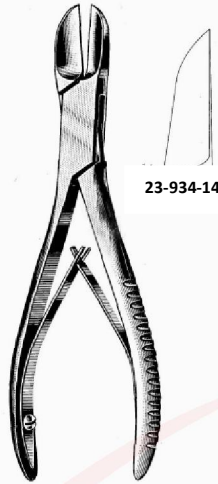

23-934-14

**LISTON BONE FORCEPS**  
 straight                      angled on flat  
 23-934-14 5 1/2"    23-935-14 5 1/2" (140mm)  
 23-934-17 6 3/4"    23-935-17 6 3/4" (171mm)  
 23-934-19 7 1/2"    23-935-19 7 1/2" (191mm)

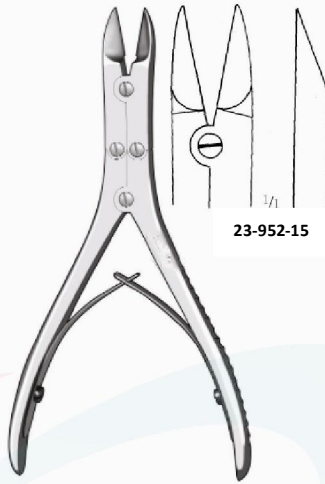

23-952-15

**RUSKIN-LISTON FORCEPS 6" (152mm)**  
 23-950-15 straight  
 23-952-15 straight delicate  
 23-951-15 curved delicate

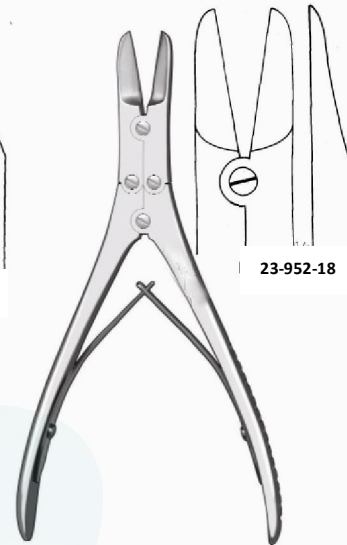

23-952-18

**RUSKIN-LISTON FORCEPS 7 1/2" (191mm)**  
 23-950-18 straight  
 23-952-18 straight delicate  
 23-951-18 angled on flat



23-887-15    23-888-15

**RUSKIN RONGEUR 6" (152mm)**  
 straight  
 23-887-15 2x14mm bite delicate  
 23-888-15 2 3x15mm bite  
 curved  
 23-890-15 3x15mm bite

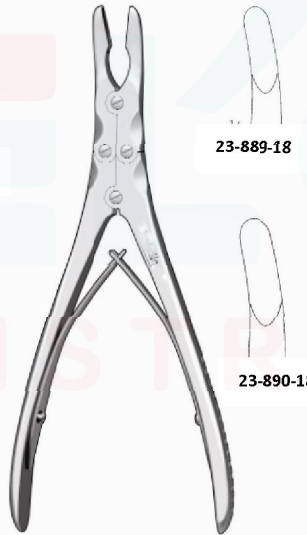

23-889-18

**RUSKIN RONGEUR 7 1/4" (184mm)**  
 straight  
 23-887-18 4x16mm bite  
 23-888-18 8 6x16mm bite  
 curved  
 23-889-18 4x16mm bite  
 23-890-18 6x16mm bite

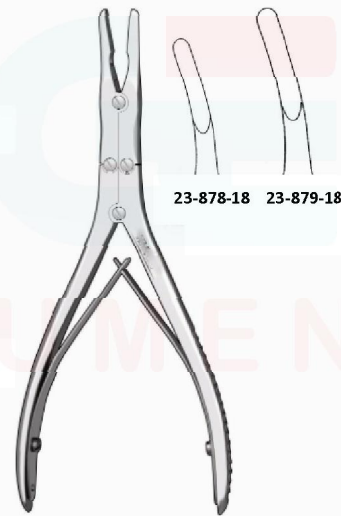

23-878-18    23-879-18

**BEYER RONGEUR 7" (178mm)**  
 curved  
 23-878-18 3x14mm bite  
 23-879-18 4x15mm bite

**ORTHOPEDIC INSTRUMENTS**

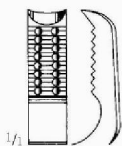

23-730-14



**KERN BONE FORCEPS**

23-730-14  
5 3/4" (146mm)  
with ratchet

23-730-21  
8 1/2" (216mm)  
with ratchet

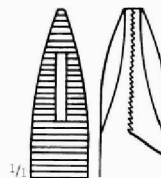

**NEEDLE NOSE PLIERS**

22-514-14  
5 1/2" (140mm)  
for wire manipulation

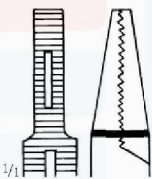

**FLAT NOSE PLIERS**

22-515-14  
5 1/2" (140mm)  
for wire manipulation

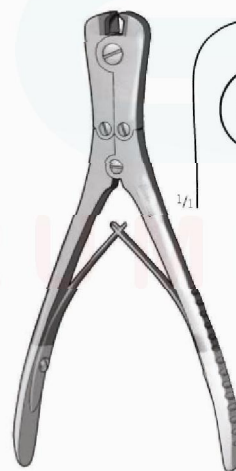
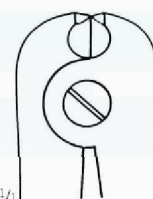

**WIRE CUTTER**

22-526-18  
7" (178mm) front and side cutting  
with carbide inserts, double action  
maximum capacity .062 (1.6mm)

**WIRE AND PIN CUTTERS**

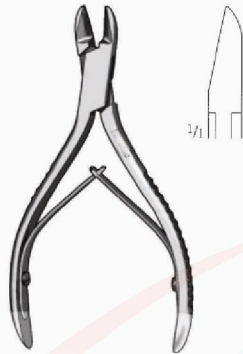

**PEDIATRIC WIRE CUTTER**  
 22-517-12  
 4 ¾" (121mm) carbide inserts  
 cuts up to .028" (0.7mm)

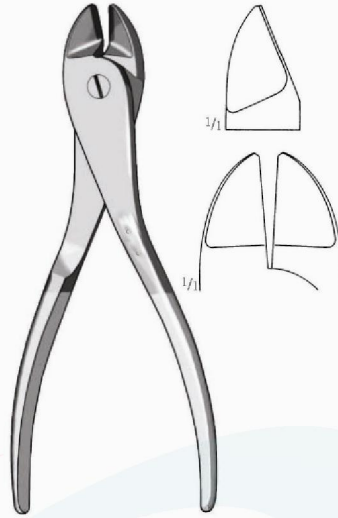

**SIDE BITE WIRE CUTTER**  
 22-523-18  
 7" (178mm) welded carbide jaws  
 cuts up to .062" (1.6mm)

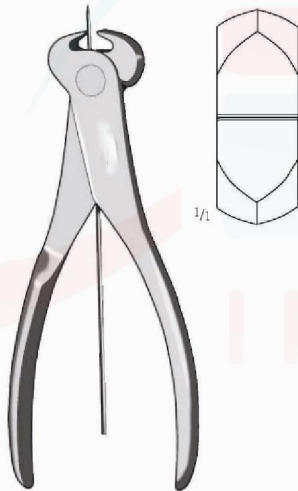

**CANNULATED PIN CUTTER**  
 22-520-18  
 7 ½" (191mm)  
 cuts up to .062" (1.6mm)

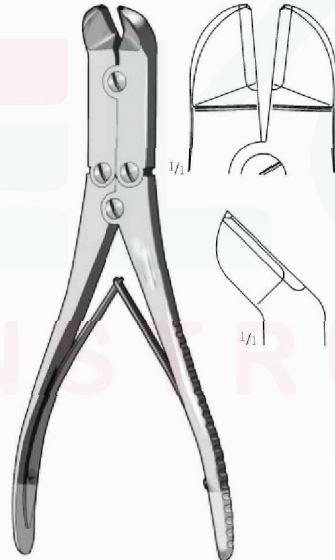

**DOUBLE ACTION WIRE CUTTER**  
 KM 46-624  
 8 ½" (216mm) angled  
 carbide inserts  
 cuts up to 3/32" (2.4mm)



**PIN CUTTER (LARGE)**  
 22-528-00  
 22" (559mm) side cutting  
 cuts up to ¼" (6.3mm)

The logo for ALGEN INSTRUMENTS features a stylized 'A' composed of a red swoosh and a teal swoosh. To the right of the 'A', the word 'ALGEN' is written in a bold, teal, sans-serif font, with red rectangular accents above the 'A' and 'E'. Below 'ALGEN', the word 'INSTRUMENTS' is written in a red, sans-serif font.

# ALGEN INSTRUMENTS

